W A L C H E M

IWAKI America Inc.

**WCN/WPH/P100 Series
Panel Mount Industrial
Controller**

Instruction Manual

Five Boynton Road Hopping Brook Park Holliston, MA 01746 USA

TEL: 508-429-1110 WEB: www.walchem.com

Notice

© 2020 WALCHEM, Iwaki America Incorporated (hereinafter "Walchem")
5 Boynton Road, Holliston, MA 01746 USA
(508) 429-1110
All Rights Reserved
Printed in USA

Proprietary Material

The information and descriptions contained herein are the property of WALCHEM. Such information and descriptions may not be copied or reproduced by any means, or disseminated or distributed without the express prior written permission of WALCHEM, 5 Boynton Road, Holliston, MA 01746.

This document is for information purposes only and is subject to change without notice.

Statement of Limited Warranty

WALCHEM warrants equipment of its manufacture, and bearing its identification to be free from defects in workmanship and material for a period of 24 months for electronics and 12 months for mechanical parts and electrodes from date of delivery from the factory or authorized distributor under normal use and service and otherwise when such equipment is used in accordance with instructions furnished by WALCHEM and for the purposes disclosed in writing at the time of purchase, if any. WALCHEM's liability under this warranty shall be limited to replacement or repair, F.O.B. Holliston, MA U.S.A. of any defective equipment or part which, having been returned to WALCHEM, transportation charges prepaid, has been inspected and determined by WALCHEM to be defective. Replaceable elastomeric parts and glass components are expendable and are not covered by any warranty.

THIS WARRANTY IS IN LIEU OF ANY OTHER WARRANTY, EITHER EXPRESS OR IMPLIED, AS TO DESCRIPTION, QUALITY, MERCHANTABILITY, FITNESS FOR ANY PARTICULAR PURPOSE OR USE, OR ANY OTHER MATTER.

180537 Rev. J June 2020

Contents

1.0 INTRODUCTION.....	1
2.0 SPECIFICATIONS	2
2.1 Measurement Performance.....	2
2.2 Electrical: Input/Output.....	3
2.3 Mechanical	5
2.4 Variables and their Limits	5
3.0 UNPACKING & INSTALLATION	8
3.1 Unpacking the unit.....	8
3.2 Mounting the electronic enclosure.....	8
3.3 Sensor Installation.....	11
3.4 Icon Definitions.....	13
3.5 Electrical installation.....	13
4.0 FUNCTION OVERVIEW	23
4.1 Front Panel.....	23
4.2 Display.....	23
4.3 Keypad	23
4.4 Icons.....	23
4.5 Startup.....	25
4.6 Shut Down.....	32
5.0 OPERATION	33
5.1 Alarms Menu	33
5.2 Inputs Menu	33
5.3 Outputs Menu	44
5.4 Settings Menu	62
6.0 MAINTENANCE.....	64
7.0 TROUBLESHOOTING.....	64
7.1 Calibration Failure	65
7.2 Alarm Messages.....	67
8.0 SERVICE POLICY	71

1.0 INTRODUCTION

The Walchem P100 Series controllers offer a high level of flexibility in controlling water treatment applications.

One sensor input is available that are compatible with a variety of sensors:

- Contacting conductivity with cell constant 0.01, 0.1, 1.0 or 10.0
- Electrodeless conductivity
- pH
- ORP
- Any Walchem disinfection sensor
- Generic sensor (Ion Selective Electrodes or any type of sensor with a linear voltage output between -2 VDC and 2 VDC)

One digital input may be used for a variety of purposes:

- State type: Flow switch or other Interlock to stop control, or drum level switch
- Water meter contactor: To control a relay to feed a chemical based on flow total
- Paddlewheel flowmeter: To control based on flow total or flow rate

Four relay outputs may be set to a variety of control modes:

- On/Off set point control
- Time Proportional control
- Pulse Proportional (when purchased with Pulse solid state opto outputs)
- PID Control (when purchased with Pulse solid state opto outputs)
- Activate with a contact closure
- Timed activation triggered by a Water Contactor or Paddlewheel flow meter's accumulated total flow
- Activate with another output
- Activate as a percent another output's on-time
- Daily, Weekly, 2-week or 4-week timers with or without Biocide functions
- Intermittent sampling for boilers with proportional blowdown, controlling on a trapped sample
- Dual set point
- Always on unless interlocked
- Probe Wash timer
- Diagnostic Alarm triggered by:
 - High or Low sensor reading
 - No Flow
 - Relay output timeout
 - Sensor error

An isolated analog output may be used to retransmit sensor input signals to a chart recorder, data logger, PLC or other device. It may also be connected to valves, actuators or metering pumps for linear proportional or PID control.

Our unique USB feature provides the ability to upgrade the software in the controller to the latest version.

2.0 SPECIFICATIONS

2.1 Measurement Performance

0.01 Cell Contacting Conductivity			
Range	0-300 μ S/cm		
Resolution	0.01 μ S/cm, 0.0001 mS/cm, 0.001 mS/m, 0.0001 S/m, 0.01 ppm		
Accuracy	\pm 1% of reading		
0.1 Cell Contacting Conductivity			
Range	0-3,000 μ S/cm		
Resolution	0.1 μ S/cm, 0.0001 mS/cm, 0.01 mS/m, 0.0001 S/m, 0.1 ppm		
Accuracy	\pm 1% of reading		
1.0 Cell Contacting Conductivity			
Range	0-30,000 μ S/cm		
Resolution	1 μ S/cm, 0.001 mS/cm, 0.1 mS/m, 0.0001 S/m, 1 ppm		
Accuracy	\pm 1% of reading		
10.0 Cell Contacting Conductivity			
Range	0-300,000 μ S/cm		
Resolution	10 μ S/cm, 0.01 mS/cm, 1 mS/m, 0.001 S/m, 10 ppm		
Accuracy	\pm 1% of reading		
pH		ORP/ISE	
Range	-2 to 16 pH units	Range	-1500 to 1500 mV
Resolution	0.01 pH units	Resolution	0.1 mV
Accuracy	\pm 0.01% of reading	Accuracy	\pm 1 mV
Disinfection Sensors			
Range (mV)	-2000 to 1500 mV	Range (ppm)	0-2 ppm to 0-20,000 ppm
Resolution (mV)	0.1 mV	Resolution (ppm)	Varies with range and slope
Accuracy (mV)	\pm 1 mV	Accuracy (ppm)	Varies with range and slope
Temperature			
Range	23 to 500°F (-5 to 60°C)		
Resolution	0.1°F (0.1°C)		
Accuracy	\pm 1% of reading		
Electrodeless Conductivity			
Ranges	Resolution		
500-12,000 μ S/cm	1 μ S/cm, 0.01 mS/cm, 0.1 mS/m, 0.001 S/m, 1 ppm		
3,000-40,000 μ S/cm	1 μ S/cm, 0.01 mS/cm, 0.1 mS/m, 0.001 S/m, 1 ppm		
10,000-150,000 μ S/cm	10 μ S/cm, 0.1 mS/cm, 1 mS/m, 0.01 S/m, 10 ppm		
50,000-500,000 μ S/cm	10 μ S/cm, 0.1 mS/cm, 1 mS/m, 0.01 S/m, 10 ppm		
200,000-2,000,000 μ S/cm	100 μ S/cm, 0.1 mS/cm, 1 mS/m, 0.1 S/m, 100 ppm		

Temperature °C	Range Multiplier
0	181.3
10	139.9
15	124.2
20	111.1
25	100.0
30	90.6
35	82.5
40	75.5
50	64.3
60	55.6
70	48.9

Temperature °C	Range Multiplier
80	43.5
90	39.2
100	35.7
110	32.8
120	30.4
130	28.5
140	26.9
150	25.5
160	24.4
170	23.6
180	22.9

Note: Conductivity ranges above apply at 25°C. At higher temperatures, the range is reduced per the range multiplier chart.

2.2 Electrical: Input/Output

<i>Input Power</i>	100 to 240 VAC, 50 or 60 Hz, 12VA
<i>Input Signals</i>	
WCNP models:	
Contacting Conductivity	0.01, 0.1, 1.0, or 10.0 cell constant OR
Electrodeless Conductivity	OR
Disinfection	OR
Amplified pH, ORP, or ISE	OR
Generic	
WPH models:	
Non-Amplified pH, ORP or ISE	
Temperature	100 or 1000 ohm RTD, 10K or 100K Thermistor
Digital Input Signals (1):	
<i>State-Type Digital Input</i>	Electrical: Optically isolated and providing an electrically isolated 9VDC power with a nominal 2.3mA current when the digital input switch is closed Typical response time: < 2 seconds Devices supported: Any isolated dry contact (i.e. relay, reed switch) Types: Interlock

Low Speed Counter-Type Digital Input	Electrical: Optically isolated and providing an electrically isolated 9VDC power with a nominal 2.3mA current when the digital input switch is closed 0-10 Hz, 50 msec minimum width Devices supported: Any device with isolated open drain, open collector, transistor or reed switch Types: Contacting Flowmeter
High Speed Counter-Type Digital Input	Electrical: Optically isolated and providing an electrically isolated 9VDC power with a nominal 2.3mA current when the digital input switch is closed, 0-500 Hz, 1.00 msec minimum width Devices supported: Any device with isolated open drain, open collector, transistor or reed switch Types: Paddlewheel Flowmeter
Outputs	
Pulse Outputs (0 or 2 depending on model):	
Opto-isolated, Solid State Relay	
200mA, 40 VDC Max.	
VLOWMAX = 0.05 V @ 18 mA	
Dry contact mechanical relays (2 or 4 depending on model):	
6 A (resistive), 1/8 HP (93 W) per relay	
Dry contact relays are not fuse protected	
4 - 20 mA (I):	
Internally powered	
Fully isolated	
600 Ohm max resistive load	
Resolution 0.0015% of span	
Accuracy \pm 0.5% of reading	
Agency Approvals	
Safety	UL 61010-1:2012 3rd Ed.
	CSA C22.2 No. 61010-1:2012 3rd Ed.
	IEC 61010-1:2010 3rd Ed.
	EN 61010-1:2010 3rd Ed.
EMC	IEC 61326-1:2012
	EN 61326-1:2013
Note: For EN61000-4-6, EN61000-4-3 the controller met performance criteria B. *Class A Equipment: Equipment suitable for use in establishments other than domestic, and those directly connected to a low voltage (100-240 VAC) power supply network which supplies buildings used for domestic purposes.	

2.3 Mechanical

Enclosure Material	Polycarbonate
Enclosure Rating	NEMA 4X (IP65)
Panel Cutout	¼ DIN (92 mm x 92 mm)
Dimensions	See Figure 3
Display	128 x 64 graphic backlit display
Operating Ambient Temp	-4 to 131 °F (-20 to 55 °C)
Storage Temperature	-4 to 176°F (-20 to 80°C)

2.4 Variables and their Limits

	Low Limit	High Limit
Sensor input settings		
Alarm limits	Low end of sensor range	High end of sensor range
Alarm dead band	Low end of sensor range	High end of sensor range
Cell constant (conductivity only)	0.01	10
Smoothing Factor	0%	90%
Comp Factor (conductivity linear ATC only)	0%	20%
Installation Factor (Electrodeless conductivity only)	0.5	1.5
Cable length	0.1	3,000
PPM conversion factor (conductivity only if units = PPM)	0.001	10,000
Sensor slope	-1,000,000	1,000,000
Sensor Offset	-1,000,000	1,000,000
Low Range	-1,000,000	1,000,000
High Range	-1,000,000	1,000,000
Default temperature	-20	500
Calibration Required Alarm	0 days	365 days
Flow meter input settings		
Totalizer alarm	0	100,000,000
Volume/contact for units of Gallons or Liters	1	100,000
Volume/contact for units of m ³	0.001	1,000
K Factor for units of Gallons or Liters	0.01	10,000
K Factor for units of m ³	1	100,000
Paddlewheel rate alarm limits	0	High end of sensor range
Paddlewheel rate alarm deadband	0	High end of sensor range
Smoothing Factor	0%	90%
Set Flow Total	0	1,000,000,000
Relay output settings		
Output Limit Time	1 second	86,400 seconds (0 = unlimited)

Hand Time Limit	1 second	86,400 seconds (0 = unlimited)
Min Relay Cycle	0 seconds	300 seconds
Set Point	Low end of sensor range	High end of sensor range
Dead Band	Low end of sensor range	High end of sensor range
Duty Cycle Period (On/Off, Dual Set Point)	0:00 minutes	59:59 minutes
Duty Cycle (On/Off, Dual Set Point)	0%	100%
Feed duration (Flow Timer mode)	0 seconds	86,400 seconds
Accumulated volume (Flow Timer mode)	0	1,000,000
Feed percentage (Bleed then Feed)	0%	100%
Feed Lockout Time Limit (Bleed & Feed, Bleed then Feed)	0 seconds	86,400 seconds
Prebleed to Conductivity (Biocide mode)	1 (0=no prebleed)	High end of sensor range
Prebleed Time (Biocide mode)	0 seconds	86,400 seconds
Bleed Lockout (Biocide mode)	0 seconds	86,400 seconds
Event Duration (Biocide, Timer modes)	0 seconds	86,400 seconds
Proportional Band (Timer or Pulse Proportional, Intermittent Mode)	Low end of sensor range	High end of sensor range
Sample period (Time Proportional mode)	10 seconds	3600 seconds
Sample Time (Intermittent Sampling mode)	0 seconds	3600 seconds
Hold Time (Probe Wash, Intermittent Sampling modes)	0 seconds	3600 seconds
Maximum Blowdown (Intermittent Sampling mode)	0 seconds	3600 seconds
Wait Time (Intermittent Sampling Mode)	0 seconds	86,400 seconds
Max Rate (Pulse Proportional, Pulse PID modes)	10 pulses/minute	480 pulses/minute
Minimum Output (Pulse Proportional, Pulse PID modes)	0%	100%
Maximum Output (Pulse Proportional, Pulse PID modes)	0%	100%
Gain (Pulse PID Standard mode)	0.001	1000.000
Integral Time (Pulse PID Standard mode)	0.001 seconds	1000.000 seconds
Derivative Time (Pulse PID Standard mode)	0 seconds	1000.000 seconds
Proportional Gain (Pulse PID Parallel mode)	0.001	1000.000
Integral Gain (Pulse PID Parallel mode)	0.001 /second	1000.000 /second
Derivative Gain (Pulse PID Parallel mode)	0 seconds	1000.000 seconds

Input Minimum (Pulse PID modes)	Low end of sensor range	High end of sensor range
Input Maximum (Pulse PID modes)	Low end of sensor range	High end of sensor range
On Delay Time (Alarm mode)	0 seconds	23:59:59 HH:MM:SS
Off Delay Time (Alarm mode)	0 seconds	23:59:59 HH:MM:SS
Analog (4-20 mA) output settings		
4 mA Value (Retransmit mode)	Low end of sensor range	High end of sensor range
20 mA Value (Retransmit mode)	Low end of sensor range	High end of sensor range
Hand Output	0%	100%
Set Point (Proportional, PID modes)	Low end of sensor range	High end of sensor range
Proportional Band (Proportional mode)	Low end of sensor range	High end of sensor range
Minimum Output (Proportional, PID modes)	0%	100%
Maximum Output (Proportional, PID modes)	0%	100%
Off Mode Output (Proportional, PID modes, Flow Prop Modes)	0 mA	21 mA
Error Output (not in Manual mode)	0 mA	21 mA
Hand Time Limit (not in Retransmit mode)	1 second	86,400 seconds (0 = unlimited)
Output Time Limit (Proportional, PID modes, Flow Prop modes)	1 second	86,400 seconds (0 = unlimited)
Gain (PID, Standard mode)	0.001	1000.000
Integral Time (PID Standard mode)	0.001 seconds	1000.000 seconds
Derivative Time (PID Standard mode)	0 seconds	1000.000 seconds
Proportional Gain (PID Parallel mode)	0.001	1000.000
Integral Gain (PID Parallel mode)	0.001 /second	1000.000 /second
Derivative Gain (PID Parallel mode)	0 seconds	1000.000 seconds
Input Minimum (PID modes)	Low end of sensor range	High end of sensor range
Input Maximum (PID modes)	Low end of sensor range	High end of sensor range
Pump Capacity (Flow Prop mode)	0 gal/hour or l/hour	10,000 gal/hour or l/hour
Pump Setting (Flow Prop mode)	0%	100%
Specific Gravity (Flow Prop mode)	0 g/ml	9.999 g/ml
Target (Flow Prop mode)	0 ppm	1,000,000 pm
Configuration Settings		
Local Password	0000	9999
Alarm Delay	0:00 minutes	59:59 minutes

3.0 UNPACKING & INSTALLATION

3.1 Unpacking the unit

Inspect the contents of the carton. Please notify the carrier immediately if there are any signs of damage to the controller or its parts. Contact your distributor if any of the parts are missing. The carton should contain a P100 series controller and an instruction manual. Any options or accessories will be incorporated as ordered.

3.2 Mounting the electronic enclosure

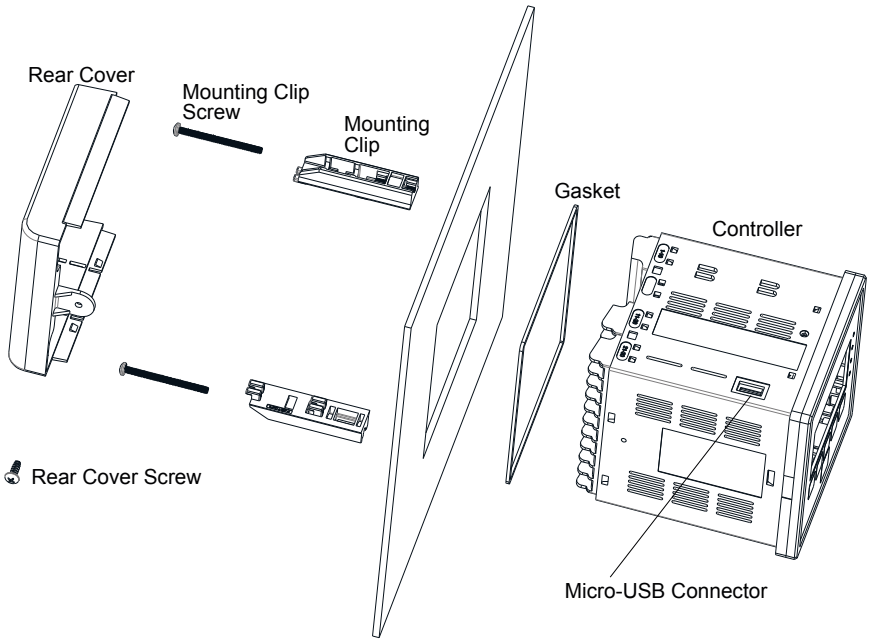

Figure 1 Exploded View

The enclosure is NEMA 4X (IP65) rated. The maximum operating ambient temperature is 131°F (55°C); this should be considered if installation is in a high temperature location.

Create the mounting hole in the panel using a ¼ DIN punch. If a punch is not available, refer to Figure 2 below for dimensions. Install the gasket onto the controller, taking care not to twist it. Insert the controller into the panel. Install the mounting clips and tighten the screws to secure the controller against the panel. After wiring, the rear cover may be installed.

Maximum panel thickness: 0.45" ± 0.02" (11.43mm ± 0.50mm)

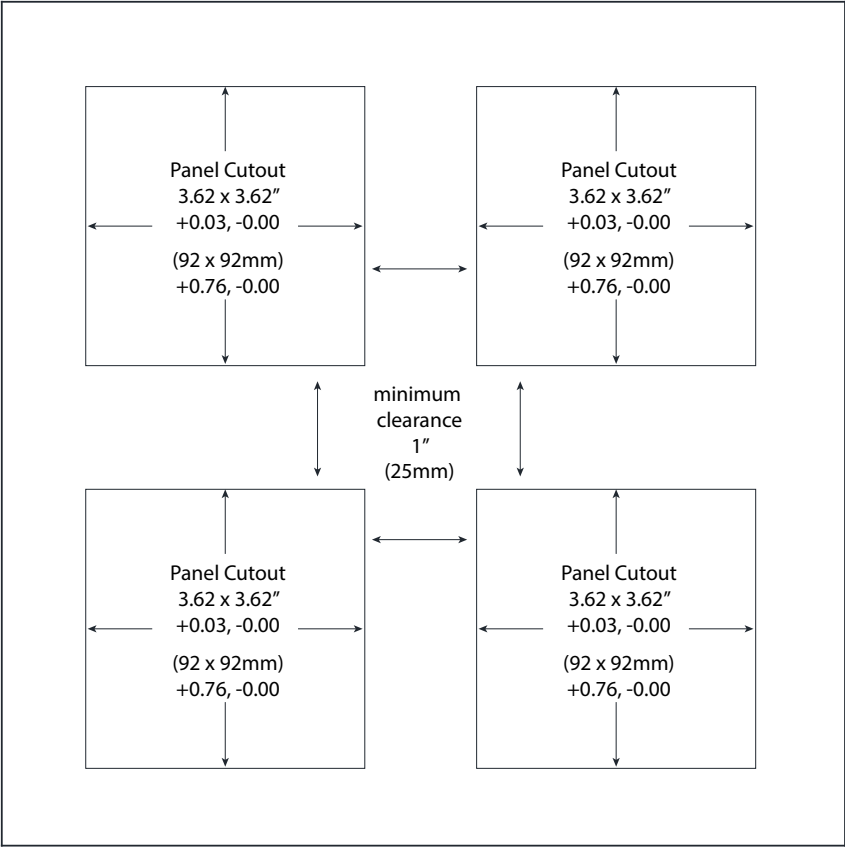

Figure 2 Panel Cutout Dimensions

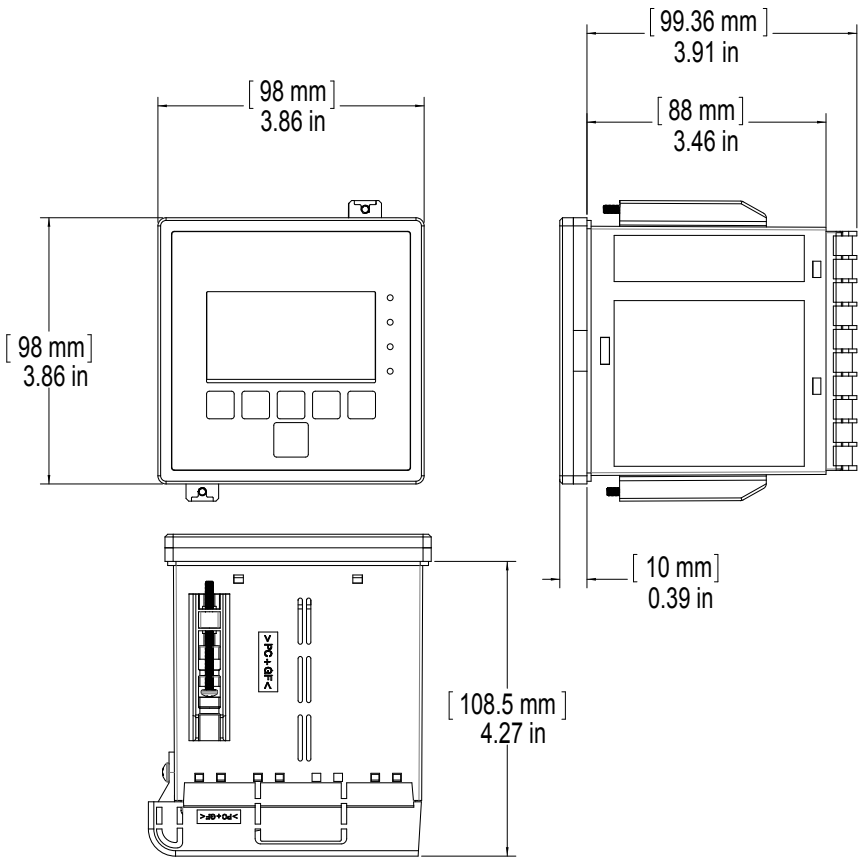

Figure 3 Controller Dimensions

3.3 Sensor Installation

Refer to the specific instructions supplied with the sensor being used, for detailed installation instructions.

General Guidelines

Locate the sensors where an active sample of water is available and where the sensors can easily be removed for cleaning. Position the sensor such that air bubbles will not be trapped within the sensing area. Position the sensor where sediment or oil will not accumulate within the sensing area.

In-Line Sensor Mounting

In-line mounted sensors must be situated so that the tee is always full and the sensors are never subjected to a drop in water level resulting in dryness. Refer to Figures 2 through 4 for typical installation.

Tap off the discharge side of the recirculation pump to provide a minimum flow of 1 gallon per minute through the flow switch manifold. The sample must flow into the bottom of the manifold in order to close the flow switch, and return to a point of lower pressure in order to ensure flow. Install an isolation valve on both sides of the manifold to stop flow for sensor maintenance.

IMPORTANT: To avoid cracking the female pipe threads on the supplied plumbing parts, use no more than 3 wraps of Teflon tape and thread in the pipe FINGER tight plus 1/2 turn! Do not use pipe dope to seal the threads of the flow switch because the clear plastic will crack!

Submersion Sensor Mounting

If the sensors are to be submersed in the process, mount them firmly to the tank, and protect the cable with plastic pipe, sealed at the top with a cable gland, to prevent premature failure. Place the sensors in an area of good solution movement.

Sensors should be located such that they respond rapidly to a well-mixed sample of the process water and the treatment chemicals. If they are too close to the chemical injection point, they will see spikes in concentration and cycle on and off too frequently. If they are too far away from the chemical injection point, they will respond too slowly to the concentration changes, and you will overshoot the set point.

The **contacting conductivity sensor** should be placed as close to the controller as possible, to a maximum distance of 250 ft. (76 m). Less than 25 ft. (8 m) is recommended. The cable must be shielded from background electrical noise. Always route low voltage (sensor) signals with at least a 6" (15 cm) separation from AC voltage wiring.



The **electrodeless conductivity sensor** should be placed as close to the controller as possible, to a maximum distance of 120 ft. (37 m). Less than 20 ft. (6m) is recommended. The cable must be shielded from background electrical noise. Always route low voltage (sensor) signals with at least a 6" (15 cm) separation from AC voltage wiring. These sensors are affected by the geometry and conductivity of their surroundings, so either maintain 6 inches (15 cm) of sample around the sensor or ensure that any nearby conductive or non-conductive items are consistently positioned. Do not install the sensor in the path of any electrical current that may be flowing in the solution, as this will shift the conductivity reading.

The **amplified pH/ORP/ISE electrode** should be placed as close to the controller as possible, to a maximum distance of 1000 feet (305 m) from the controller. A junction box and shielded cable are available to extend the standard 20 foot (6 m) length. pH and ORP electrodes must be installed such that the measuring surfaces will always remain wet. A U-trap provided in the manifold design should achieve this, even if the sample flow stops. These electrodes also must be installed with the measuring surfaces pointing down; that is 5 degrees above the horizontal, at a minimum. **Non-amplified pH/ORP/ISE electrodes** are only compatible with WPHNP or WPHBP models, and the coax cable should not be extended beyond 20 feet (6 m).

The **disinfection sensor** should be placed as close to the controller as possible, to a maximum distance of 100 feet (30 m) from the controller. A junction box and shielded cable are available to extend the standard 20 foot (6 m) length. The sensor should be mounted such that the measuring surfaces will always stay wet. If the membrane dries out, it will respond slowly to changing disinfectant values for 24 hours, and if dried out repeatedly, will fail prematurely. The flow cell should be placed on the discharge side of a circulation pump or downhill from a gravity feed. Flow into the cell must come from the bottom side that has the 3/4" x 1/4" NPT reducing bushing installed.

The reducing bushing provides the flow velocity required for accurate readings and must not be removed! A "U" trap should be installed so that if the flow stops, the sensor is still immersed in the water. The outlet of the flow cell must be plumbed to open atmosphere unless the system pressure is at or below 1 atmosphere. If the flow through the line cannot be stopped to allow for cleaning and calibration of the sensor, then it should be placed in a by-pass line with isolation valves to allow for sensor removal. Install the sensor vertically, with the measuring surface pointing down, at least 5 degrees above horizontal. Flow rate regulation must be done upstream from the sensor, because any flow restriction downstream can increase the pressure above atmospheric and damage the membrane cap!

3.4 Icon Definitions

Symbol	Publication	Description
	IEC 417, No.5019	Protective Conductor Terminal
	IEC 417, No. 5007	On (Supply)
O	IEC 417, No. 5008	Off (Supply)
	ISO 3864, No. B.3.6	Caution, risk of electric shock
	ISO 3864, No. B.3.1	Caution

3.5 Electrical installation

Refer to figures 4 through 12 for wiring.

Note: when wiring the 4-20 mA output or a remote flow switch, it is advisable to use stranded, twisted, shielded pair wire between 22-26 AWG. Shield should be terminated at the controller.

	 CAUTION
1.	There are live circuits inside the controller! The controller must never be opened before power to the controller is REMOVED!
2.	When mounting the controller, make sure there is clear access to the disconnecting device!
3.	The electrical installation of the controller must be done by trained personnel only and conform to all applicable National, State and Local codes!
4.	Proper grounding of this product is required. Any attempt to bypass the grounding will compromise the safety of persons and property.
5.	Operating this product in a manner not specified by Walchem may impair the protection provided by the equipment.

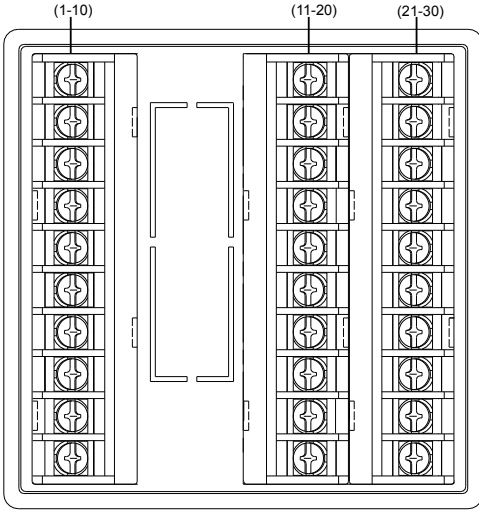

TERM 2

No.	ECOND	CCOND
11	XMT+	XMT
12	XMT-	
13	TEMP+	TEMP+
14	TEMP-	TEMP-
15	RCV+	
16	RCV-	
17	SHIELD	SHIELD
18		RCV
19		
20		

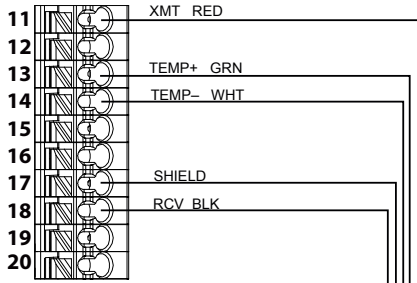

TERM 2

Conductivity Electrode

Figure 4 Contacting Conductivity Sensor Input Wiring

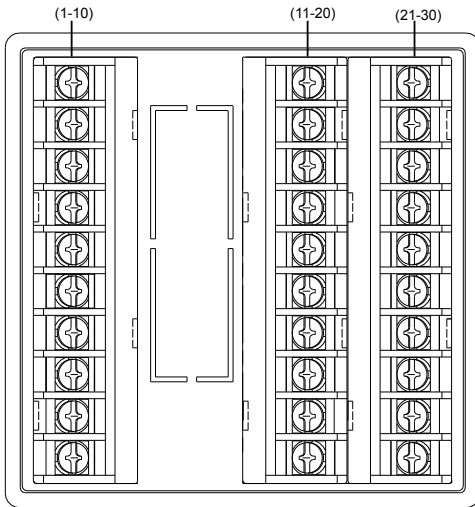

TERM 2

No.	ECOND	CCOND
11	XMT+	XMT
12	XMT-	XMT
13	TEMP+	TEMP+
14	TEMP-	TEMP-
15	RCV+	
16	RCV-	
17	SHIELD	SHIELD
18		RCV
19		
20		

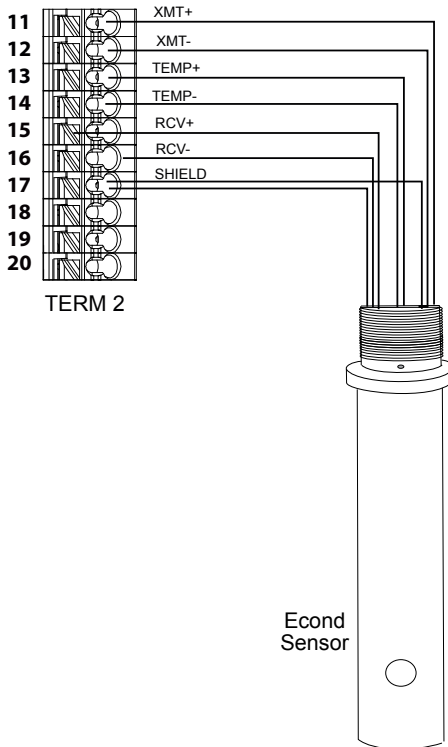
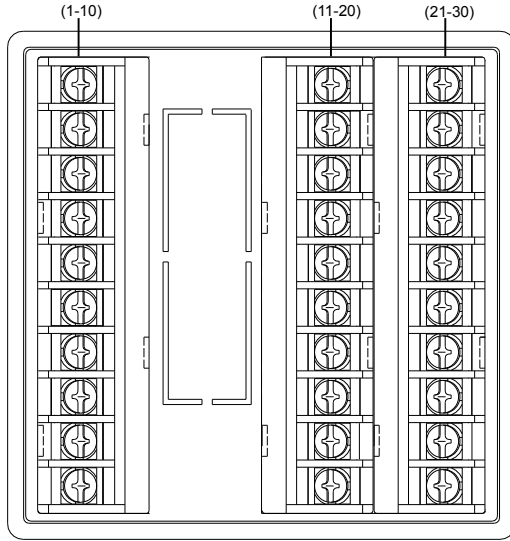

Figure 5 Electrodeless Conductivity Sensor Input Wiring



TERM 2

No.	PASSIVE pH/ORP
11	GLASS
12	REF
13	TEMP+
14	TEMP-
15	
16	
17	SHIELD
18	
19	
20	

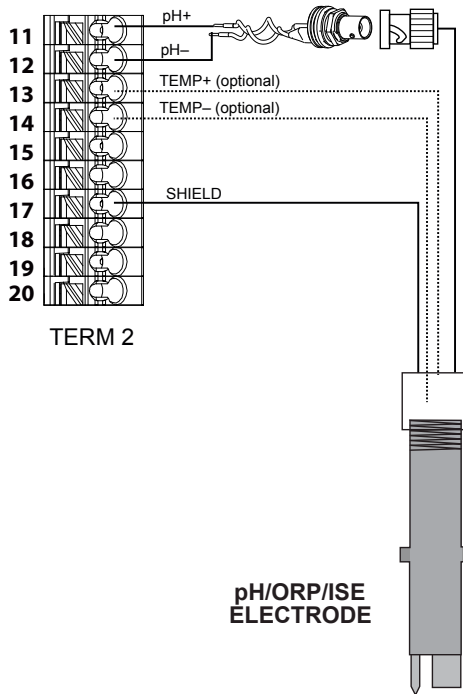
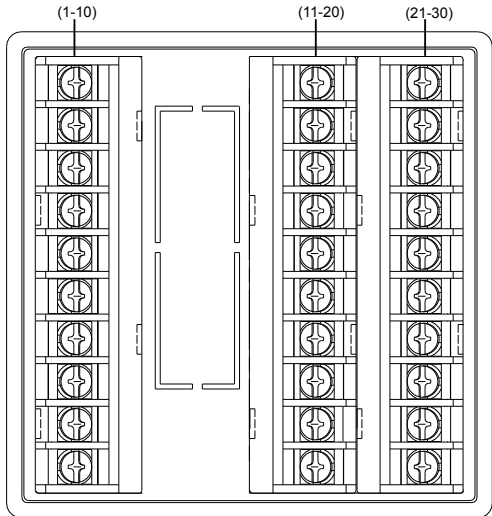

Figure 6 Non-Amplified pH/ORP/ISE Sensor Input Wiring with BNC



TERM 2

No.	PASSIVE pH/ORP
11	GLASS
12	REF
13	TEMP+
14	TEMP-
15	
16	
17	SHIELD
18	
19	
20	

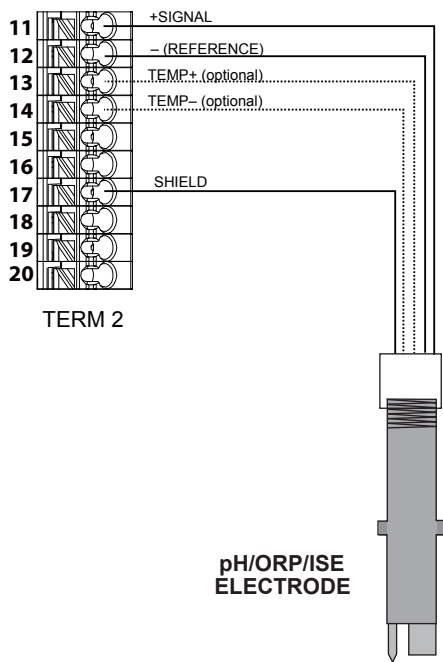
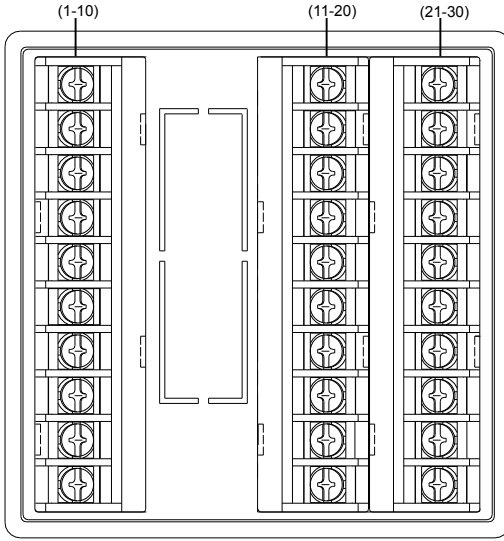
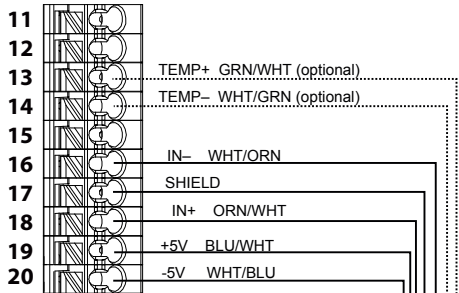

Figure 7 Non-Amplified pH/ORP/ISE Sensor Input Wiring



TERM 2

No.	pH/ORP DIS
11	
12	
13	TEMP+
14	TEMP-
15	
16	IN-
17	SHIELD
18	IN+
19	+5V
20	-5V



TERM 2

pH/ORP
ELECTRODE

Figure 8 Amplified pH/ORP/ISE Sensor Input Wiring

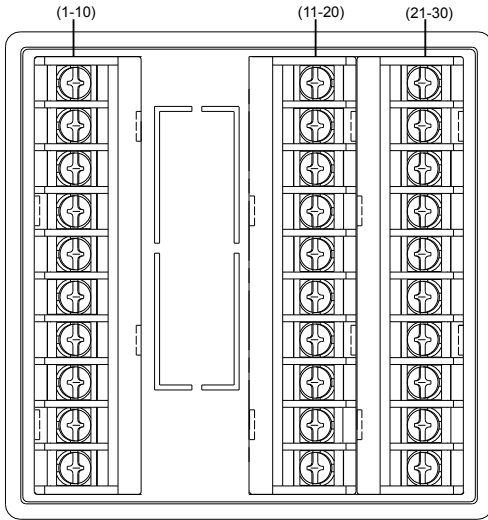

TERM 2

No.	pH/ORP DIS
11	
12	
13	TEMP+
14	TEMP-
15	
16	IN-
17	SHIELD
18	IN+
19	+5V
20	-5V

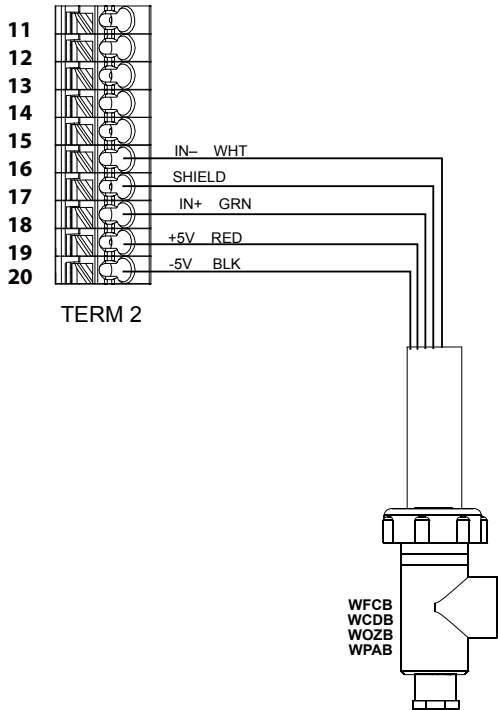
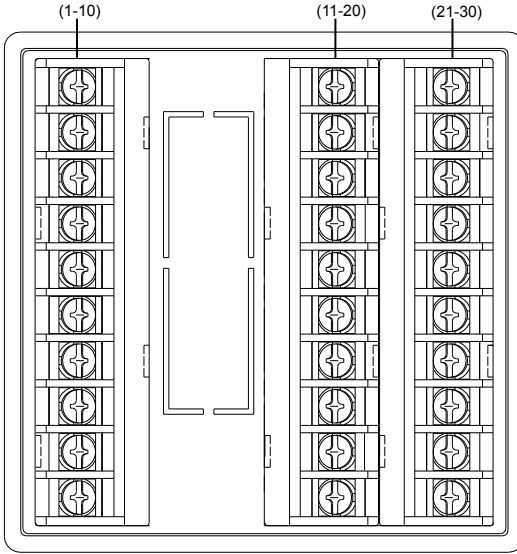

Figure 9 Disinfection Sensor Input Wiring



TERM 1

No.	Function
1	⏏
2	LAC 100-420V
3	NAC 100-240V
4	SHIELD
5	SHIELD
6	SHIELD
7	4-20 OUT+
8	4-20 OUT-
9	DIG IN +
10	DIG IN -

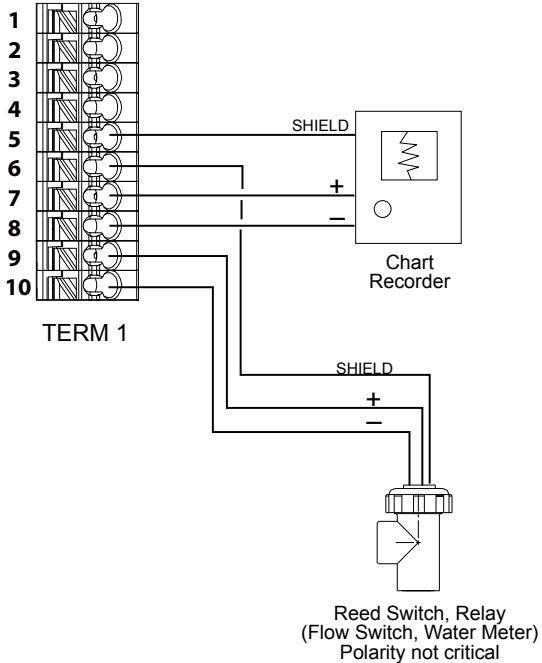
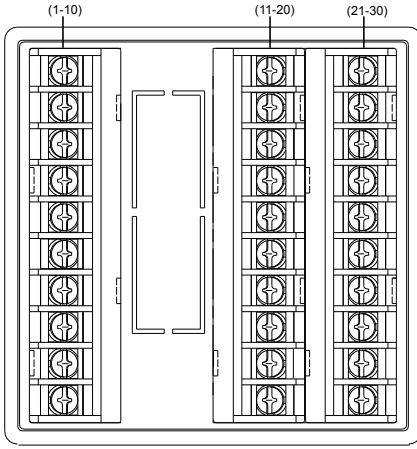
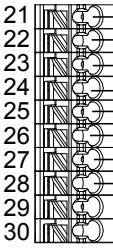

Figure 10 Digital Input /Analog Output Wiring



No.	Relays
21	R1
22	
23	
24	R2
25	
26	R3
27	
28	R4
29	
30	

TERM 3



TERM 3

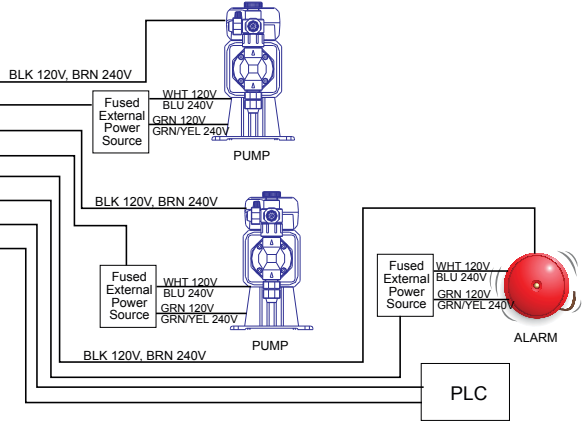

TERM 1

No.	Function
1	⏏
2	LAC 100-420V
3	NAC 100-240V
4	SHIELD
5	SHIELD
6	SHIELD
7	4-20 OUT+
8	4-20 OUT-
9	DIG IN +
10	DIG IN -

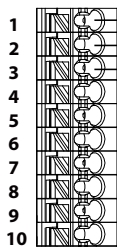

TERM 1

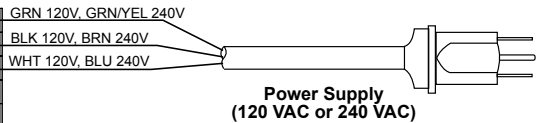

Power Supply
(120 VAC or 240 VAC)

Figure 11 P110 AC Power & Relay Output Wiring

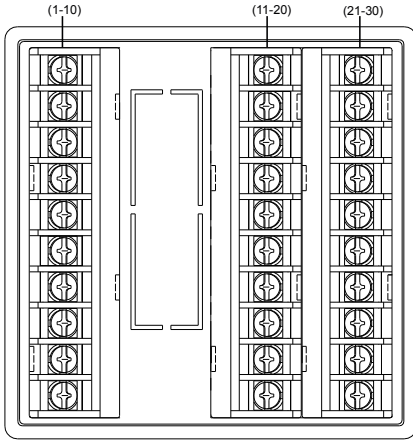

No.	Relays
21	
22	R1
23	
24	R2
25	R3+
26	R3-
27	R4+
28	R4-
29	
30	

TERM 3

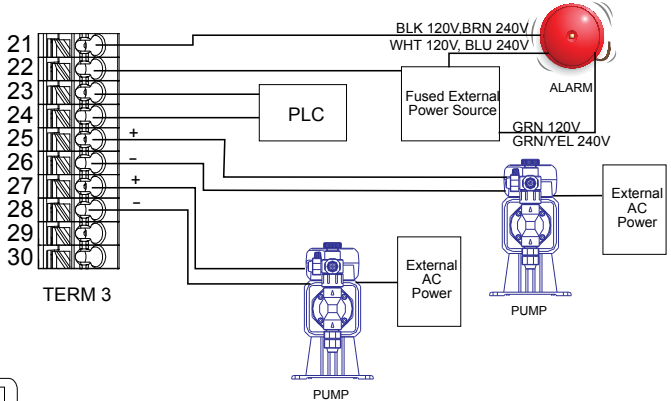

TERM 1

No.	Function
1	⏏
2	LAC 100-420V
3	NAC 100-240V
4	SHIELD
5	SHIELD
6	SHIELD
7	4-20 OUT+
8	4-20 OUT-
9	DIG IN +
10	DIG IN -

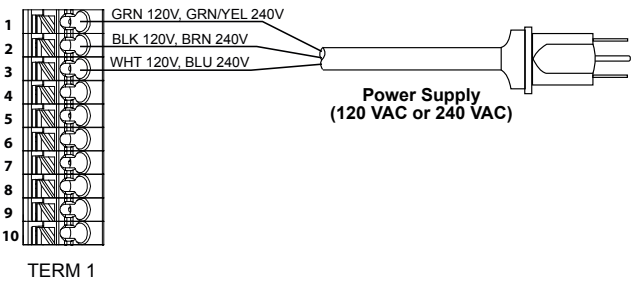

TERM 1

Figure 12 P120 AC Power & Relay Output Wiring

4.0 FUNCTION OVERVIEW

4.1 Front Panel

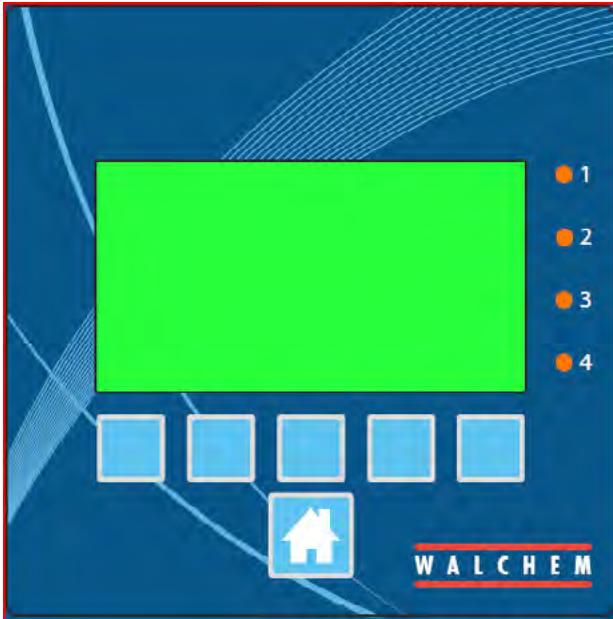

Figure 13 Front Panel

4.2 Display

A Home screen is displayed while the controller is on. This display shows the sensor readings, active alarms and a row of icons that are used to navigate to other screens.



4.3 Keypad

The keypad consists of 5 ATM type keys and a Home key used to return to the Home screen. The icon above the ATM keys will define its purpose on the current screen being displayed.











4.4 Icons

The following icons appear on the Home screen. Press the key below the icon to get to the main menu selections.

	Alarm Menu
---	------------

	Inputs Menu
	Outputs Menu
	Settings Menu

Other icons may appear in the menu screens.

	Calibration key appears in sensor input menus and brings up the calibration menu
	Cancel key cancels any entry
	The Page Down icon scrolls down to a new page in a list of options.
	The Page Up icon scrolls up to a new page in a list of options.
	The Confirm icon accepts a choice and advances to the next calibration step
	The Back/Return icon returns the display to the previous screen
	The Make Character Higher key is used when making an alphanumeric entry
	The Make Character Lower key is used when making an alphanumeric entry
	The Move Cursor key is used to scroll left to right within an alphanumeric entry
	The ENTER key is used to finish entering data or enter a highlighted menu choice

Overview of the use of keys

Changing Numeric Values

To change a number, use the Move Cursor key to the digit to be changed. If the new number will be negative, start with the sign using the Make Character Higher key. Move the cursor to each digit and change the value using either the Make Character Higher or Lower keys. Once the value of the number is correct use the Enter key to store the new value into memory, or use the Cancel key to leave the

number at its previous value and go back.

Changing Names

To change the name used to identify an input or output, use the Move Cursor key to the character to be changed and change it using either the Make Character Higher or Lower keys. Upper case and lower case letter, numbers, a blank space, period, plus and minus symbols are available. Move the cursor to the right and modify each character. Once the word is correct, use the Enter key to store the new value into memory, or use the Cancel key to leave the word at its previous value and go back.

Choosing from a List

Selecting the type of sensor, the units of measure of an input, or the control mode used for an output, the selection is picked from a list of available options. Use the Page Up or Down keys to highlight the desired option, and then use the Enter key to store the new option into memory, or use the Return key to leave the option at its previous value and go back.

Hand-Off-Auto Relay Mode

Use the Left or Right Move Cursor keys to highlight the desired relay mode. In Hand mode the relay is forced on for a specified amount of time and when that time is up the relay returns to its previous mode, in Off mode the relay is always off until taken out of Off mode, and in Auto mode the relay is responding to control set points. Use the Confirm key to accept the option, or the Return key to leave the option at its previous value and go back.

Interlock and Force On Menus

To select which outputs to force on, or which outputs to be interlocked, use the Move Cursor key to highlight the output to be selected, then use the Make Character Higher or Lower keys to check or uncheck that output. When finished, press the Confirm key to accept the changes or the Cancel key to leave the selections at the previous settings and go back.

4.5 Startup

Initial Startup

After having mounted the enclosure and wired the unit, the controller is ready to be started. Plug in the controller and turn on the power switch to supply power to the unit. The display will briefly show the model number and then revert to the normal summary display. Press the Home key if necessary to get to the Home screen. Refer to section 5 below for more details on each of the settings. Config Menu (see section 5.4)

Choose language

Press the Configuration Settings key. Press the Enter key. Press the Scroll Down key until the English word “Language” is highlighted. Press the Enter key. Press the Scroll Down key until your language is highlighted. Press the Confirm key to change all menus to your language.

Set date (if necessary)

Press the Scroll Up key until Date is highlighted. Press the Enter key. Press the Move Cursor key to highlight the Day, and then use the Make Character Higher or Lower keys to change the date. Press the Confirm key to accept the change.

Set time (if necessary)

Press the Scroll Down key until Time is highlighted. Press the Enter key. Press the Move Cursor key to highlight the HH (hour) and/or MM (minute), then use the Make Character Higher or Lower keys to change the time. Press the Confirm key to accept the change.

Set global units of measure

Press the Scroll Down key until Global Units is highlighted. Press the Enter key. Press the Scroll Down key until the desired units is highlighted. Press the Confirm key to accept the change.

Set temperature units of measure

Press the Scroll Down key until Temp Units is highlighted. Press the Enter key. Press the Scroll Down key until the desired units is highlighted. Press the Confirm key to accept the change.

Press the Home key. Press the Inputs key.



Alarms(1)
Sensor (S1)
Temp (S2)

CONFIG
Global Settings
Security Settings

Additional Config Settings:
 Display Settings
 File Utilities
 Controller Details

Config > Global Settings
Date 2017-Mar-22
Time 15:49:16

Additional Global Settings:
 Global Units
 Temperature Units
 Alarm Delay
 HVAC Modes
 Language

Config > Security Settings
Controller Log Out
Security

Additional Security Settings:
 Local Password

Config > Display Settings
Home 1
Home 2

Additional Display Settings:
 Adjust Display
 Key Beep

Config > File Utilities
File Transfer Status
Export Event Log

Additional File Utilities:
 Import User Config File
 Export User Config File
 Export System Log
 Restore Default Config
 Software Upgrade

Config > Controller Details
Controller
Product Name

Additional Controller Details:
 Control Board
 Software Version
 Sensor Board
 Software Version
 Power Board
 Battery Power
 Internal Temp 1
 Internal Temp 2



INPUTS

Inputs	
CCond (S1)	0 µS/cm
Temp (S2)	74.7 °F
· ▲ ▼ ▶	

⚠ No Alarms (1)	
CCond (S1)	0 µS/cm
Temp (S2)	74.7°F
▲ ▲ ▲ ▲	

>> CCond (S1) > Calibration	
One Point Process Calibration	
One Point Buffer Calibration	
Two Point Buffer Calibration	
Three Point Buffer Calibration	
Open Air Calibration	
Zero Calibration	
· ▲ ▼ ▶	

(All)
(CCond,ECond,pH,ORP,Generic)
(ECond,pH,ORP,Generic)
(pH)
(Cond)
(Disinfection,Linear Generic)

Inputs>CCond (S1)	
Details Screen	
Content varies with output type	
· ▼ ⊕ ✕	

>>CCond (S1)	
Alarms	
Deadband	
· ▼ ▶	

Additional Settings for CCond:
Reset Calibration Values
Cal Required Alarm
Alarm Suppression
Smoothing Factor
Default Temp
Temp Compensation
Temp Comp Factor
Cell Constant
Cable Length
Gauge
Units
Name
Type

>>Generic (S1)	
Alarms	
Deadband	
· ▼ ▶	

Additional Settings for Generic:
Reset Calibration Values
Cal Required Alarm
Alarm Suppression
Smoothing Factor
Sensor Slope
Sensor Offset
Low Range
High Range
Cable Length
Gauge
Units
Electrode (Linear Ion Selective)
Name
Type

>>ECond (S1)	
Alarms	
Deadband	
· ▼ ▶	

Additional Settings for ECond:
Reset Calibration Values
Cal Required Alarm
Alarm Suppression
Smoothing Factor
Default Temp
Installation Factor
Range
Temp Compensation
Temp Comp Factor
Cell Constant
Cable Length
Gauge
Units
Name
Type

>>DI State (D1)	
Open Message	
Closed Message	
· ▼ ▶	

Additional Settings for DI State:
Interlock
Alarm
Alarm Suppression
Total Time
Reset Total Time
Name
Type

>>Temperature (S2)	
Alarms	
Deadband	
· ▼ ▶	

Additional Settings for Temperature:
Reset Calibration Values
Cal Required Alarm
Alarm Suppression
Smoothing Factor
Name
Element

Contactor Type	
>>Flowmeter (D1)	
Totalizer Alarm	
Reset Flow Total	
· ▼ ▶	

Additional Settings for Flowmeter:
Set Flow Total
Scheduled Reset
Alarm Suppression
Volume/Contact
Flow Units
Name
Type

>>pH (S1)	
Alarms	
Deadband	
· ▼ ▶	

Additional Settings for pH:
Reset Calibration Values
Cal Required Alarm
Alarm Suppression
Smoothing Factor
Buffers
Default Temp
Cable Length
Gauge
Electrode
Name
Type

Paddlewheel Type	
>>Flowmeter (D1)	
Alarms	
Deadband	
· ▼ ▶	

Additional Settings for Flowmeter:
Alarm Suppression
Totalizer Alarm
Reset Flow Total
Set Flow Total
Scheduled Reset
K Factor
Flow Units
Rate Units
Smoothing Factor
Name
Type

>>ORP (S1)	
Alarms	
Deadband	
· ▼ ▶	

Additional Settings for ORP:
Reset Calibration Values
Cal Required Alarm
Alarm Suppression
Smoothing Factor
Default Temp
Cable Length
Gauge
Name
Type

Only Available in some models

>>Disinfection (S1)	
Alarms	
Deadband	
· ▼ ▶	

Additional Settings for Disinfection:
Reset Calibration Values
Cal Required Alarm
Alarm Suppression
Smoothing Factor
Cable Length
Gauge
Sensor
Name
Type



OUTPUTS R1-R3

Outputs>On/Off (R1-R3)
Details Screen
Content varies with output type

· [v] [x]

Outputs	
On/Off (R1-R3)	Off
Bleed (R2)	Off
[^] [v] [↔]	

⚠ No Alarms (1)	
CCond (S1)	0 μS/cm
Temp (S2)	74.7°F
[⚠] [↔] [↕] [x]	

>>On/Off (R1-R3)>Settings

HOA Setting

Setpoint

· [v] [x]

Additional Settings for On/Off:

Deadband	Min Relay Cycle
Duty Cycle Period	Hand Time Limit
Duty Cycle	Reset Time Total
Output Time Limit	Reset Time Total
Reset Output Timeout	Input
Interlock Channels	Direction
Activate with Channels	Name
	Mode

>>Time Prop (R1-R3)

HOA Setting

Setpoint

· [v] [x]

Additional Settings for Time Prop:

Proportional Band	Hand Time Limit
Sample Period	Reset Time Total
Output Time Limit	Input
Reset Output Timeout	Direction
Interlock Channels	Name
Activate with Channels	Mode
Min Relay Cycle	

>>Flow Timer (R1-R3)

HOA Setting

Feed Duration

· [v] [x]

Additional Settings for Flow Timer:

Accumulated Volume	Hand Time Limit
Reset Timer	Reset Time Total
Reset Output Timeout	Bleed
Interlock Channels	Flow Input
Activate with Channels	Name
Min Relay Cycle	Mode

Only if HVAC mode is enabled

>>Int Sampling (R1-R3)

HOA Setting

Setpoint

· [v] [x]

Additional Settings for Int Sampling:

Proportional Band	Interlock Channels
Deadband	Activate with Channels
Sample Time	Min Relay Cycle
Hold Time	Hand Time Limit
Maximum Blowdown	Reset Time Total
Wait Time	Cond Input
Trap Sample	Name
Output Time Limit	Mode
Reset Output Timeout	

Only if HVAC mode is enabled

>>Bleed and Feed (R1-R3)

HOA Setting

Feed Time Limit

· [v] [x]

Additional Settings for Bleed and Feed:

Output Time Limit	Hand Time Limit
Reset Output Timeout	Reset Time Total
Interlock Channels	Bleed
Activate with Channels	Name
Min Relay Cycle	Mode

>>Manual (R1-R3)

HOA Setting

Interlock Channels

· [v] [x]

Additional Settings for Manual:

Min Relay Cycle	
Hand Time Limit	
Reset Time Total	
Name	
Mode	

Only if HVAC mode is enabled

>>Bleed then Feed (R1-R3)

HOA Setting

Feed Percentage

· [v] [x]

Additional Settings for Bleed then Feed:

Feed Time Limit	Hand Time Limit
Reset Timer	Reset Time Total
Reset Output Timeout	Bleed
Interlock Channels	Name
Activate with Channels	Mode
Min Relay Cycle	

Only if model W120/power relay bd installed

>>Pulse Prop (R1-R3)

HOA Setting

Setpoint

· [v] [x]

Additional Settings for Pulse Prop:

Proportional Band	Min Relay Cycle
Min Output	Hand Time Limit
Max Output	Reset Time Total
Max Rate	Input
Output Time Limit	Direction
Reset Output Timeout	Name
Interlock Channels	Mode
Activate with Channels	

>>Percent Timer (R1-R3)

HOA Setting

Sample Period

· [v] [x]

Additional Settings for Percent Timer:

Feed Percentage	Hand Time Limit
Interlock Channels	Reset Time Total
Activate with Channels	Name
Min Relay Cycle	Mode

>>Dual Setpoint (R1-R3)

HOA Setting

Setpoint

· [v] [x]

Additional Settings for Dual Setpoint:

Set Point 2	Min Relay Cycle
Deadband	Hand Time Limit
Duty Cycle Period	Reset Time Total
Duty Cycle	Input
Output Time Limit	Direction
Reset Output Timeout	Name
Interlock Channels	Mode
Activate with Channels	

Only if HVAC mode is enabled

>>Biocide Timer (R1-R3)

HOA Setting

Bleed

· [v] [x]

Additional Settings for Biocide Timer:

Event 1 (through 10)	Repetition	Bleed Lockout
Week	Day	Add Last Missed
Start Time	Duration	Interlock Channels
Duration	Start Time	Activate with Channels
Preamble Time	Week	Min Relay Cycle
Preamble To	Day	Hand Time Limit
Cond Input	Events per Day	Reset Time Total
	Start Time	Name
	Duration	Mode

>>Probe Wash (R1-R3)

HOA Setting

Input

· [v] [x]

Additional Settings for Probe Wash:

Input 2	Interlock Channels
Event 1 (through 10)	Activate with Channels
Repetition	Min Relay Cycle
Week	Hand Time Limit
Day	Reset Time Total
Events per Day	Hand Time Limit
Start Time	Reset Time Total
Duration	Name
Sensor Mode	Mode
Hold Time	

>>Alarm (R1-R3)

HOA Setting

Alarm Mode

· [v] [x]

Additional Settings for Alarm:

On Delay Time	Hand Time Limit
Off Delay Time	Reset Time Total
Output	Name
Interlock Channels	Mode
Activate with Channels	
Min Relay Cycle	

Only if HVAC mode is disabled

>>Timer (R1-R3)

HOA Setting

Add Last Missed

· [v] [x]

Additional Settings for Timer:

Event 1 (through 10)	Min Relay Cycle
Repetition	Hand Time Limit
Week	Reset Time Total
Day	Name
Events per Day	Mode
Start Time	
Duration	
Interlock Channels	
Activate with Channels	



OUTPUT A1

Output>Retrans (A1)
 Details on this page vary with type of output

Output	
On/Off (R1)	Off
Retrans (A1)	0.0%

⚠ No Alarms (1)	
CCond (S1)	0 µS/cm
Temp (S2)	74.7°F

>>Retransmit (A1)

HOA Setting
4 mA Value

- Additional Settings for Retransmit:
- 20 mA Value
 - Hand Output
 - Interlock Channels
 - Error Output
 - Reset Time Total
 - Input Name
 - Mode

>>Proportional (A1)

HOA Setting
Setpoint

- Additional Settings for Proportional:
- Proportional Band
 - Min Output
 - Max Output
 - Output Time Limit
 - Reset Output Timeout
 - Interlock Channels
 - Activate with Channels
 - Hand Output
 - Hand Time Limit
 - Reset Time Total
 - Off Mode Output
 - Error Output
 - Input Direction
 - Name
 - Mode

Only available if HVAC is disabled

>>PID (A1)

HOA Setting
Setpoint

- Additional Settings for PID:
- Gain
 - Proportional Gain
 - Integral Time
 - Integral Gain
 - Derivative Time
 - Derivative Gain
 - Reset PID Integral
 - Min Output
 - Max Output
 - Max Rate
 - Output Time Limit
 - Reset Output Timeout
 - Interlock Channels
 - Activate with Channels
 - Hand Output
 - Hand Time Limit
 - Off Mode Output
 - Error Output
 - Reset Time Total
 - Input Direction
 - Input Min
 - Input Max
 - Gain Form
 - Name
 - Mode

>>Manual (A1)

HOA Setting
Interlock Channels

- Additional Settings for Manual:
- Activate with Channels
 - Min. Relay Cycle
 - Hand Output
 - Hand Time Limit
 - Reset Time Total
 - Name
 - Mode

>>Flow Prop (A1)

HOA Setting
Target

- Additional Settings for Flow Prop Control Mode:
- Pump Capacity
 - Pump Setting
 - Specific Gravity
 - Output Time Limit
 - Reset Output Timeout
 - Interlock Channels
 - Activate with Channels
 - Hand Output
 - Hand Time Limit
 - Off Mode Output
 - Error Output
 - Reset Time Total
 - Flow Input
 - Name
 - Mode

Inputs (see section 5.2)

Program the settings for each input

The S1 sensor input will be highlighted. Press the Enter key to get to the Details screen. Press the Settings key. If the name of the sensor does not describe the type of sensor connected, press the Scroll Down key until Type is highlighted. Press the Enter key. Press the Scroll Down key until the correct type of sensor is highlighted, then press the Confirm key to accept the change. This will bring you back to the Details screen. Press the Settings key again to finish the rest of the S1 settings. For disinfections sensors, choose the exact sensor in the Sensor menu. For contacting conductivity sensors, enter the cell constant. Select the units of measure. Enter the alarm set points and alarm deadband. Set the default temperature that will be used for automatic temperature compensation if the temperature signal becomes invalid.

When finished with S1, press the Return key until the list of inputs is displayed. Press the Scroll Down key and repeat the process for each input.

The S2 temperature input Element should be set correctly once the S1 sensor type has been set. If not, select the correct temperature element and set the alarm set points and alarm deadband. Generic, ORP and disinfection sensors do not have temperature signals and are preset to No Sensor.

To calibrate the temperature, return to the S2 Details screen, press the Calibrate key, and press the Enter key to perform a calibration.

If a flow switch or liquid level switch is connected, D1 should be set to DI State type (if no switch is connected, select No Sensor). Set the state that will possibly interlock control outputs (refer to the Outputs settings to program which outputs, if any, will be interlocked by the switch). Set the state, if any, that will result in an alarm.

If a contacting head or paddlewheel flow meter is connected, D1 should be set to that type (if no flow meter is connected, select No Sensor). Set the units of measure, volume/contact or K factor, etc.

Calibrate the sensor

To calibrate the sensor, return to the list of inputs, highlight S1, press the Enter key, press the Calibrate key, and select one of the calibration routines. For Disinfection and Generic sensors, start with the Zero Calibration. For electrodeless conductivity, start with the Air Calibration. Refer to section 5.2.

Press the Home key. Press the Outputs key.

Outputs (see section 5.3)

Program the settings for each output

The R1 relay output will be highlighted. Press the Enter key to get to the Details

screen. Press the Settings key. If the name of the relay does not describe the control mode desired, press the Scroll Down key until Mode is highlighted. Press the Enter key. Press the Scroll Down key until the correct control mode is highlighted, then press the Confirm key to accept the change. This will bring you back to the Details screen. Press the Settings key again to finish the rest of the R1 settings.

If you want the output to be interlocked by a flow switch or by another output being active, enter the Interlock Channels menu and select the input or output channel that will interlock this output.

The default is for the output to be in Off mode, where the output does not react to the settings. Once all settings for that output are complete, enter the HOA Setting menu and change it to Auto.

Repeat for each output.

Normal Startup

Startup is a simple process once your set points are in memory. Simply check your supply of chemicals, turn on the controller, and calibrate the sensor if necessary and it will start controlling.

4.6 Shut Down

To shut the controller down, simply turn off the power. Programming remains in memory.

5.0 OPERATION

These units control continuously while power is applied. Programming is accomplished via the local keypad and display.

To see the top level menu keys, press the Home key if not already there. The menu structure is grouped by Alarms, Inputs, Outputs, and configuration Settings. Each input has its own menu for calibration and unit selection as needed. Each output has its own setup menu including set points, timer values and operating modes as needed. Under Settings will be general settings such as the clock, the language, etc.

Keep in mind that even while moving through menus, the unit is still controlling.

5.1 Alarms Menu

Press the key below the Alarms icon to view a list of active alarms. If there are more than two active alarms, the Page Down icon will be shown, and this key press will bring up the next page of inputs.

Press the Back/Return button to go back to the previous screen.

5.2 Inputs Menu

Press the key below the Inputs icon to view a list of all sensor and digital inputs. The Page Down icon scrolls down the list of inputs, the Page Up icon scrolls up the list of inputs, the Return icon brings back the previous screen.

Press the Enter key with an input highlighted to access that input's details, calibration (if applicable) and settings.

Sensor Input Details

The details for any type of sensor input include the current value read, alarms, the raw (uncalibrated) signal, the sensor type, and the calibration gain and offset. If the sensor has automatic temperature compensation, then the sensor's temperature value and alarms, the temperature resistance value read, and the type of temperature element required are also displayed.

Calibration

Press the Calibration key to calibrate the sensor. Select the calibration to perform: One Point Process, One Point Buffer or Two Point Buffer Calibration. Not all calibration options are available for all types of sensor.

One Point Process Calibration

New Value

Enter the actual value of the process as determined by another meter or laboratory analysis and press Confirm.

Cal Successful or Failed

If successful, press Confirm to put the new calibration in memory.

If failed, you may retry the calibration or cancel. Refer to Section 7 to troubleshoot a calibration failure.

One Point Buffer Calibration, Disinfection /Generic Sensor Zero Cal, Conductivity Air Cal

Cal Disables Control

Press Confirm to continue or Cancel to abort

Buffer Temperature (only appears if no temperature sensor is detected for sensor types that use automatic temperature compensation)

Enter the temperature of the buffer and press Confirm.

Buffer Value (only appears for One Point Calibration except when automatic buffer recognition is used)

Enter the value of the buffer being used

Rinse Sensor

Remove the sensor from the process, rinse it off, and place it in the buffer solution (or oxidizer-free water for Zero Cal, or air for the conductivity open air cal). Press Confirm when ready.

Stabilization

When the temperature (if applicable) and signal from the sensor is stable, the controller will automatically move to the next step. If they don't stabilize you may manually go to the next step by pressing Confirm.

Cal Successful or Failed

If successful, press Confirm to put the new calibration in memory.

If failed, you may retry the calibration or cancel. Refer to Section 7 to troubleshoot a calibration failure.

Resume Control

Replace the sensor in the process and press Confirm when ready to resume control.

Two Point Buffer Calibration

Cal Disables Control

Press Confirm to continue or Cancel to abort

Buffer Temperature (only appears if no temperature sensor is detected for sensor types that use automatic temperature compensation)

Enter the temperature of the buffer and press Confirm.

First Buffer Value (does not appear if automatic buffer recognition is used)

Enter the value of the buffer being used

Rinse Sensor

Remove the sensor from the process, rinse it off, and place it in the buffer solution. Press Confirm when ready.

Stabilization

When the temperature (if applicable) and signal from the sensor is stable, the controller will automatically move to the next step. If they don't stabilize you may manually go to the next step by pressing Confirm.

Second Buffer Temperature (only appears if no temperature sensor is detected for sensor types that use automatic temperature compensation)

Enter the temperature of the buffer and press Confirm.

Second Buffer Value (does not appear if automatic buffer recognition is used)

Enter the value of the buffer being used

Rinse Electrode

Remove the sensor from the process, rinse it off, and place it in the buffer solution. Press Confirm when ready.

Stabilization

When the temperature (if applicable) and signal from the sensor is stable, the controller will automatically move to the next step. If they don't stabilize you may manually go to the next step by pressing Confirm.

Cal Successful or Failed

If successful, press Confirm to put the new calibration in memory. The calibration adjusts the offset and the gain (slope) and displays the new values. If failed, you may retry the calibration or cancel. Refer to Section 7 to troubleshoot a calibration failure.

Resume Control

Replace the sensor in the process and press Confirm when ready to resume control.

Three Point Buffer Calibration (pH sensors only)

Cal Disables Control

Press Confirm to continue or Cancel to abort

Buffer Temperature (only appears if no temperature sensor is detected)

Enter the temperature of the buffer and press Confirm.

First Buffer Value (does not appear if automatic buffer recognition is used)

Enter the value of the buffer being used

Rinse Sensor

Remove the sensor from the process, rinse it off, and place it in the buffer solution. Press Confirm when ready.

Stabilization

When the temperature (if applicable) and signal from the sensor is stable, the controller will automatically move to the next step. If they don't stabilize you may manually go to the next step by pressing Confirm.

Second Buffer Temperature (only appears if no temperature sensor is detected)

Enter the temperature of the buffer and press Confirm.

Second Buffer Value (does not appear if automatic buffer recognition is used)

Enter the value of the buffer being used

Rinse Electrode

Remove the sensor from the process, rinse it off, and place it in the buffer solution. Press Confirm when ready.

Stabilization

When the temperature (if applicable) and signal from the sensor is stable, the controller will automatically move to the next step. If they don't stabilize you may manually go to the next step by pressing Confirm.

Third Buffer Temperature (only appears if no temperature sensor is detected)

Enter the temperature of the buffer and press Confirm.

Third Buffer Value (does not appear if automatic buffer recognition is used)

Enter the value of the buffer being used

Rinse Electrode

Remove the sensor from the process, rinse it off, and place it in the buffer solution. Press Confirm when ready.

Stabilization

When the temperature (if applicable) and signal from the sensor is stable, the controller will automatically move to the next step.

Cal Successful or Failed

If successful, press Confirm to put the new calibration in memory. The calibration adjusts the offset, gain (slope) and calibration midpoint and displays the new values. If failed, you may retry the calibration or cancel. Refer to Section 7 to troubleshoot a calibration failure.

Resume Control

Replace the sensor in the process and press Confirm when ready to resume control.

5.2.1 Contacting Conductivity

Settings

Press the Settings key view or change the settings related to the sensor.

Alarms	Low-Low, Low, High and High-High Alarms limits may be set.
Deadband	This is the Alarm Deadband. For example, if the High Alarm is 3000, and the deadband is 10, the alarm will activate at 3001 and deactivate at 2990.
Reset Calibration Values	Enter this menu to reset the sensor calibration back to factory defaults.
Cal Required Alarm	To get an alarm message as a reminder to calibrate the sensor on a regular schedule, enter the number of days between calibrations. Set it to 0 if no reminders are necessary.
Alarm Suppression	If any of the relays or digital inputs are selected, any alarms related to this input will be suppressed if the selected relay or digital input is active. Typically this is used to prevent alarms if there is no sample flow past the flow switch digital input.
Smoothing Factor	Increase the smoothing factor percentage to dampen the response to changes. For example, with a 10% smoothing factor, the next reading shown will consist of an average of 10% of the previous value and 90% of the current value.
Cable Length	The controller automatically compensates for errors in the reading caused by varying the length of the cable.
Gauge	The cable length compensation depends upon the gauge of wire used to extend the cable
Cell Constant	Change the cell constant to match the sensor connected.
Default Temp	If the temperature signal is lost at any time, then the controller will use the Default Temp setting for temperature compensation.
Temp Comp	Select between the standard NaCl temperature compensation method or a linear %/ degree C method.
Comp Factor	This menu only appears if Linear Temp Comp is selected. Change the %/degree C to match the chemistry being measured. Standard water is 2%.
Units	Select the units of measure for the conductivity.
Name	The name used to identify the sensor may be changed.
Type	Select the type of sensor to be connected.

5.2.2 pH

Settings

Press the Settings key view or change the settings related to the sensor.

Alarms	Low-Low, Low, High and High-High Alarms limits may be set.
Deadband	This is the Alarm Deadband. For example, if the High Alarm is 9.50, and the deadband is 0.05, the alarm will activate at 9.51 and deactivate at 9.45.
Reset Calibration Values	Enter this menu to reset the sensor calibration back to factory defaults.
Cal Required Alarm	To get an alarm message as a reminder to calibrate the sensor on a regular schedule, enter the number of days between calibrations. Set it to 0 if no reminders are necessary.
Alarm Suppression	If any of the relays or digital inputs are selected, any alarms related to this input will be suppressed if the selected relay or digital input is active. Typically this is used to prevent alarms if there is no sample flow past the flow switch digital input.
Smoothing Factor	Increase the smoothing factor percentage to dampen the response to changes. For example, with a 10% smoothing factor, the next reading shown will consist of an average of 10% of the previous value and 90% of the current value.
Buffers	Select if calibration buffers will be manually entered, or if they will be automatically detected, and if so, which set of buffers will be used. The choices are Manual Entry, JIS/ NIST Standard, DIN Technical, or Traceable 4/7/10.
Default Temp	If the temperature signal is lost at any time, then the controller will use the Default Temp setting for temperature compensation.
Cable Length	The controller automatically compensates for errors in the reading caused by varying the length of the cable.
Gauge	The cable length compensation depends upon the gauge of wire used to extend the cable
Electrode	Select Glass for a standard pH electrode, or Antimony. Antimony pH electrodes have a default slope of 49 mV/pH and an offset of -320 mV at pH 7.
Name	The name used to identify the sensor may be changed.
Type	Select the type of sensor to be connected.

5.2.3 ORP

Settings

Press the Settings key view or change the settings related to the sensor.

Alarms	Low-Low, Low, High and High-High Alarms limits may be set.
---------------	--

Deadband	This is the Alarm Deadband. For example, if the High Alarm is 800, and the deadband is 10, the alarm will activate at 801 and deactivate at 790.
Reset Calibration Values	Enter this menu to reset the sensor calibration back to factory defaults.
Cal Required Alarm	To get an alarm message as a reminder to calibrate the sensor on a regular schedule, enter the number of days between calibrations. Set it to 0 if no reminders are necessary.
Alarm Suppression	If any of the relays or digital inputs are selected, any alarms related to this input will be suppressed if the selected relay or digital input is active. Typically this is used to prevent alarms if there is no sample flow past the flow switch digital input.
Smoothing Factor	Increase the smoothing factor percentage to dampen the response to changes. For example, with a 10% smoothing factor, the next reading shown will consist of an average of 10% of the previous value and 90% of the current value.
Cable Length	The controller automatically compensates for errors in the reading caused by varying the length of the cable.
Gauge	The cable length compensation depends upon the gauge of wire used to extend the cable
Name	The name used to identify the sensor may be changed.
Type	Select the type of sensor to be connected.

5.2.4 Disinfection

Settings

Press the Settings key view or change the settings related to the sensor.

Alarms	Low-Low, Low, High and High-High Alarms limits may be set.
Deadband	This is the Alarm Deadband. For example, if the High Alarm is 7.00, and the deadband is 0.1, the alarm will activate at 7.01 and deactivate at 6.90.
Reset Calibration Values	Enter this menu to reset the sensor calibration back to factory defaults.
Cal Required Alarm	To get an alarm message as a reminder to calibrate the sensor on a regular schedule, enter the number of days between calibrations. Set it to 0 if no reminders are necessary.
Alarm Suppression	If any of the relays or digital inputs are selected, any alarms related to this input will be suppressed if the selected relay or digital input is active. Typically this is used to prevent alarms if there is no sample flow past the flow switch digital input.
Smoothing Factor	Increase the smoothing factor percentage to dampen the response to changes. For example, with a 10% smoothing factor, the next reading shown will consist of an average of 10% of the previous value and 90% of the current value.

Cable Length	The controller automatically compensates for errors in the reading caused by varying the length of the cable.
Gauge	The cable length compensation depends upon the gauge of wire used to extend the cable
Name	The name used to identify the sensor may be changed.
Sensor	Select the specific type and range of disinfection sensor to be connected.
Type	Select the type of sensor to be connected.

5.2.5 Electrodeless Conductivity

Settings

Press the Settings key view or change the settings related to the sensor.

Alarms	Low-Low, Low, High and High-High Alarms limits may be set.
Deadband	This is the Alarm Deadband. For example, if the High Alarm is 3000, and the deadband is 10, the alarm will activate at 3000 and deactivate at 2990.
Reset Calibration Values	Enter this menu to reset the sensor calibration back to factory defaults.
Cal Required Alarm	To get an alarm message as a reminder to calibrate the sensor on a regular schedule, enter the number of days between calibrations. Set it to 0 if no reminders are necessary.
Alarm Suppression	If any of the relays or digital inputs are selected, any alarms related to this input will be suppressed if the selected relay or digital input is active. Typically this is used to prevent alarms if there is no sample flow past the flow switch digital input.
Smoothing Factor	Increase the smoothing factor percentage to dampen the response to changes. For example, with a 10% smoothing factor, the next reading shown will consist of an average of 10% of the previous value and 90% of the current value.
Default Temp	If the temperature signal is lost at any time, then the controller will use the Default Temp setting for temperature compensation.
Temp Comp	Select between the standard NaCl temperature compensation method or a linear %/ degree C method.
Comp Factor	This menu only appears if Linear Temp Comp is selected. Change the %/degree C to match the chemistry being measured. Standard water is 2%.
Installation Factor	Do not change unless instructed by the factory.
Cable Length	The controller automatically compensates for errors in the reading caused by varying the length of the cable.
Gauge	The cable length compensation depends upon the gauge of wire used to extend the cable

Cell Constant	Do not change unless instructed by the factory.
Range	Select the range of conductivity that best matches the conditions the sensor will see.
Units	Select the units of measure for the conductivity.
Name	The name used to identify the sensor may be changed.
Type	Select the type of sensor to be connected.

5.2.6 Generic Sensor

Settings

Press the Settings key view or change the settings related to the sensor.

Alarms	Low-Low, Low, High and High-High Alarms limits may be set.
Deadband	This is the Alarm Deadband. For example, if the High Alarm is 7.00, and the deadband is 0.1, the alarm will activate at 7.01 and deactivate at 6.90.
Reset Calibration Values	Enter this menu to reset the sensor calibration back to factory defaults.
Cal Required Alarm	To get an alarm message as a reminder to calibrate the sensor on a regular schedule, enter the number of days between calibrations. Set it to 0 if no reminders are necessary.
Alarm Suppression	If any of the relays or digital inputs are selected, any alarms related to this input will be suppressed if the selected relay or digital input is active. Typically this is used to prevent alarms if there is no sample flow past the flow switch digital input.
Smoothing Factor	Increase the smoothing factor percentage to dampen the response to changes. For example, with a 10% smoothing factor, the next reading shown will consist of an average of 10% of the previous value and 90% of the current value.
Cable Length	The controller automatically compensates for errors in the reading caused by varying the length of the cable.
Gauge	The cable length compensation depends upon the gauge of wire used to extend the cable
Units	The word to be used for units of measure may be entered (ppm, for example)
Electrode	Select the type of electrode to be connected. Select Linear if the sensor slope is a linear voltage per Units. Select Ion Selective if the electrode voltage output is logarithmic, defined as “mV/decade”.
Sensor Slope	Enter the slope of sensor in mV/Units (if Electrode selection is Linear) or mV/Decade (if Electrode selection is Ion Selective).

Sensor Offset	Only appears if the Electrode selection is Linear. Enter the offset of the sensor in mV if 0 mV is not equal to 0 units. For Ion Selective Electrodes, the Sensor Offset is not calculated until the first calibration is performed, and the sensor will read Zero until a calibration has been successfully completed!
Low Range	Enter the low end of the range of the sensor
High Range	Enter the high end of the range of the sensor
Name	The name used to identify the sensor may be changed.
Type	Select the type of sensor to be connected.

5.2.7 Temperature

Settings

Press the Settings key view or change the settings related to the sensor.

Alarms	Low-Low, Low, High and High-High Alarms limits may be set.
Deadband	This is the Alarm Deadband. For example, if the High Alarm is 100, and the deadband is 1, the alarm will activate at 100 and deactivate at 99.
Reset Calibration Values	Enter this menu to reset the sensor calibration back to factory defaults.
Cal Required Alarm	To get an alarm message as a reminder to calibrate the sensor on a regular schedule, enter the number of days between calibrations. Set it to 0 if no reminders are necessary.
Alarm Suppression	If any of the relays or digital inputs are selected, any alarms related to this input will be suppressed if the selected relay or digital input is active.
Smoothing Factor	Increase the smoothing factor percentage to dampen the response to changes. For example, with a 10% smoothing factor, the next reading shown will consist of an average of 10% of the previous value and 90% of the current value.
Name	The name used to identify the sensor may be changed.
Element	Select the specific type of temperature sensor to be connected.

5.2.8 DI State

Input Details

The details for this type of input include the current state with a custom message for open versus closed, alarms, and the status of the interlock.

Settings

Press the Settings key view or change the settings related to the sensor.

Open Message	The words used to describe the switch state may be customized.
---------------------	--

Closed Message	The words used to describe the switch state may be customized.
Interlock	Choose whether the input should be in the interlocked state when the switch is either open or closed.
Alarm	Choose if an alarm should be generated when the switch is open, or closed, or if no alarm should ever be generated.
Alarm Suppression	If any of the relays or digital inputs are selected, any alarms related to this input will be suppressed if the selected relay or digital input is active.
Total Time	Choose to totalize the amount of time that the switch has been open or closed. This will be displayed on the input details screen.
Reset Total Time	Enter this menu to reset the accumulated time to zero. Press Confirm to accept, Cancel to leave the total at the previous value and go back.
Name	The name used to identify the switch may be changed.
Type	Select the type of sensor to be connected to the digital input channel.

5.2.9 Flow Meter, Contactor Type

Input Details

The details for this type of input include the total volume accumulated through the flow meter and alarms.

Settings

Press the Settings key view or change the settings related to the sensor.

Totalizer Alarm	A high limit on the total volume of water accumulated may be set.
Alarm Suppression	If any of the relays or digital inputs are selected, any alarms related to this input will be suppressed if the selected relay or digital input is active.
Reset Flow Total	Enter this menu to reset the accumulated flow total to 0. Press Confirm to accept, Cancel to leave the total at the previous value and go back.
Set Flow Total	This menu is used to set the total volume stored in the controller to match the register on the flow meter. Enter the desired value.
Scheduled Reset	Choose to automatically reset the flow total, and if so, Daily, Monthly or Annually.
Volume/Contact	Enter the volume of water that needs to go through the flow meter in order to generate a contact closure.
Flow Units	Select the units of measure for the water volume.
Name	The name used to identify the sensor may be changed.
Type	Select the type of sensor to be connected to the digital input channel.

5.2.10 Flow Meter, Paddlewheel Type

Input Details

The details for this type of input include the current flow rate, total volume accumulated through the flow meter and alarms.

Settings

Press the Settings key view or change the settings related to the sensor.

Alarms	Low and High Alarm limits may be set.
Alarm Suppression	If any of the relays or digital inputs are selected, any alarms related to this input will be suppressed if the selected relay or digital input is active.
Deadbands	This is the Alarm Deadband. For example, if the High Alarm is 100, and the deadband is 1, the alarm will activate at 100 and deactivate at 99.
Totalizer Alarm	A high limit on the total volume of water accumulated may be set.
Reset Flow Total	Enter this menu to reset the accumulated flow total to 0. Press Confirm to accept, Cancel to leave the total at the previous value and go back.
Set Flow Total	This menu is used to set the total volume stored in the controller to match the register on the flow meter. Enter the desired value.
Scheduled Reset	Choose to automatically reset the flow total, and if so, Daily, Monthly or Annually.
K Factor	Enter the pulses generated by the paddlewheel per unit volume of water.
Flow Units	Select the units of measure for the water volume.
Rate Units	Select the units of measure for the flow rate time base.
Smoothing Factor	Increase the smoothing factor percentage to dampen the response to changes. For example, with a 10% smoothing factor, the next reading shown will consist of an average of 10% of the previous value and 90% of the current value.
Name	The name used to identify the sensor may be changed.
Type	Select the type of sensor to be connected to the digital input channel.

5.3 Outputs Menu

Press the key below the Outputs icon to view a list of all relay and analog outputs. The Page Down icon scrolls down the list of outputs, the Page Up icon scrolls up the list of outputs, the Return icon brings back the previous screen. Press the Enter key with an output highlighted to access that output's details and settings.

NOTE: When the output control mode or the input assigned to that output is

changed, the output reverts to OFF mode. Once you have changed all settings to match the new mode or sensor, you must put the output into AUTO mode to start control.

5.3.1 Relay, Any Control Mode

Output Details

The details for this type of output include the relay on/off state, HOA mode or Interlock status, accumulated on-time, alarms, current cycle on time and relay type.

Settings

Press the Settings key view or change the settings related to the relay. Settings that are available for any control mode include:

HOA Setting	Select Hand, Off or Auto mode (see section 4.4).
Output Time Limit	Enter the maximum amount of time that the relay can be continuously activated. Once the time limit is reached, the relay will deactivate until the Reset Output Timeout menu is entered.
Reset Output Timeout	Enter this menu to clear an Output Timeout alarm and allow the relay to control the process again.
Interlock Channels	Select the relays and digital inputs that will interlock this relay, when those other relays are activated in Auto mode. Using Hand or Off to activate relays bypasses the Interlock logic.
Activate With Channels	Select the relays and digital inputs that will activate this relay, when those other relays are activate in Auto Mode. Using Hand or Off to activate relays bypasses the 'Activate With' logic.
Min Relay Cycle	This menu allows for the use of a motorized ball valve that needs time to fully open and close. Enter the number of seconds that the valve needs to fully actuate
Hand Time Limit	Enter the amount of time that the relay will activate for when it is in Hand mode.
Reset Time Total	Press the Confirm icon to reset the total accumulated on-time stored for the output back to 0.
Name	The name used to identify the relay may be changed.
Mode	Select the desired control mode for the output.

5.3.2 Relay, On/Off Control Mode

Output Details

The details for this type of output include the relay on/off state, HOA mode or Interlock status, accumulated on-time, alarms, current cycle on time and relay type.

Settings

Press the Settings key view or change the settings related to the relay.

Set point	Enter the sensor process value at which the relay will activate.
Deadband	Enter the sensor process value away from the set point at which the relay will deactivate.
Duty Cycle Period	Using a duty cycle helps to prevent overshooting the set point in applications where the response of the sensor to chemical additions is slow. Specify the amount of time for the cycle, and the percentage of that cycle time that the relay will be active. The relay will be off for the rest of the cycle, even if the set point has not been satisfied. Enter the length of the duty cycle in minutes:seconds in this menu. Set the time to 00:00 if use of a duty cycle is not required.
Duty Cycle	Enter the percentage of the cycle period that the relay will be active. Set the percentage to 100 if use of a duty cycle is not required.
Input	Select the sensor to be used by this relay.
Direction	Select the control direction.

5.3.3 Relay, Alarm Mode

Output Details

The details for this type of output include the relay on/off state, HOA mode or Interlock status, accumulated on-time, alarms, current cycle on time and relay type.

Settings

Press the Settings key view or change the settings related to the relay.

Alarm Mode	Select the alarm conditions that will put the relay into the alarm state: All Alarms S1 Low Alarms (+LoLo Alarm, Sensor Range Error, or Sensor Fault) S1 High Alarms (+HiHi Alarm, Sensor Range Error, or Sensor Fault) S2 (Temperature) Low Alarms (+LoLo Alarm, Sensor Range Error, or Sensor Fault) S2 (Temperature) High Alarms (+HiHi Alarm, Sensor Range Error, or Sensor Fault) D1 Alarms (Flowswitch/State, Flow Total, Flowmeter Range) D2 Alarms (Flowswitch/State, Flow Total, Flowmeter Range) Relay Alarms (Output Timeout, Control Failure, Event Skipped) for ALL relays
On Delay Time	Enter the delay time for relay activation in hours:minutes:seconds. Set the time to 00:00:00 to immediately activate the relay.
Off Delay Time	Enter the delay time for relay deactivation in hours:minutes:seconds. Set the time to 00:00:00 to immediately deactivate the relay.
Output	Select if the relay will be active when in the alarm state (Normally Open) or if the relay will be active when not in the alarm state (Normally Closed).

5.3.4 Relay, Time Proportional Control Mode

Output Details

The details for this type of output include the relay on/off state, HOA mode or Interlock status, accumulated on-time, alarms, current cycle on time and relay type.

Settings

Press the Settings key view or change the settings related to the relay.

Set point	Enter the sensor process value at which the relay will be off for the entire Sample Period.
Proportional Band	Enter the distance that the sensor process value is away from the set point at which the relay will be on for the entire Sample Period. Enter the conductivity value above the set point at which the maximum blowdown time will occur. For example, if the Set point is 2000 uS/cm, and the Proportional Band is 200 uS/cm, then if the conductivity is above 2200 uS/cm the blowdown valve will open for the Maximum Blowdown time described below. If the conductivity of the trapped sample is 2100 uS/cm, the blowdown valve will open for half the Maximum Blowdown time.
Sample Period	Enter the duration of the sample period.
Input	Select the sensor to be used by this relay.
Direction	Select the control direction.

5.3.5 Relay, Pulse Proportional Control Mode

ONLY AVAILABLE IF HVAC MODE IS DISABLED IN CONFIG MENU – GLOBAL SETTINGS

Output Details

The details for this type of output include the relay pulse rate, HOA mode or Interlock status, accumulated on-time, alarms, current cycle on time and relay type.

Settings

Press the Settings key view or change the settings related to the relay.

Set point	Enter the sensor process value at which the output will pulse at the Minimum Output % set below.
Proportional Band	Enter the distance that the sensor process value is away from the set point beyond which the output will be pulsing at the Maximum Output % set below.
Minimum Output	Enter the lowest possible pulse rate as a percentage of the Maximum Stroke Rate set below (normally 0%).
Maximum Output	Enter the highest possible pulse rate as a percentage of the Maximum Stroke Rate set below.
Maximum Rate	Enter the maximum pulse rate that the metering pump is designed to accept (10 - 360 pulse/minute range).

Input	Select the sensor to be used by this relay.
Direction	Set the control direction.

5.3.6 Relay, PID Control Mode

ONLY AVAILABLE IF CONTROLLER INCLUDES PULSE OUTPUT HARDWARE AND HVAC MODE IS DISABLED

The PID algorithm controls a solid state relay using standard Proportional-Integral-Derivative control logic. The algorithm provides feedback control based on an error value continuously calculated as the difference between a measured process variable and a desired set point. Tuning settings specify the response for proportional (the size of the error), integral (the time that the error has been present), and derivative (the rate of change for the error) parameters. With proper tuning, the PID control algorithm can hold the process value close the set point while minimizing overshoot and undershoot.

Normalized Error

The error value versus set point that is calculated by the controller is normalized and represented as percent of full scale. As a result, tuning parameters entered by the user are not dependent upon the scale of the process variable and the PID response with similar settings will be more consistent even when using different types of sensor inputs.

The scale used to normalize the error is dependent upon the type of sensor selected. By default, the full nominal range of the sensor is used. This range is editable by the user if tighter control is desired.

PID Equation Formats

The controller supports two different forms of the PID equation as specified by the Gain Form setting. The two forms require different units for entry of the PID tuning parameters.

Standard

The standard form is more commonly used in industry because its time-based settings for the integral and derivative coefficients are more meaningful. This form is selected by default.

Parameter	Description	Units
K_p	Gain	unitless
T_i	Integral Time	seconds or seconds/repeat
T_d	Derivative Time	seconds

$$Output (\%) = K_p \left[e(t) + \frac{1}{T_i} \int e(t)dt + T_d \frac{de(t)}{dt} \right]$$

Parameter	Description	Units
-----------	-------------	-------

e(t)	Current Error	% of full scale
dt	Delta Time Between Readings	seconds
de(t)	Difference Between Current Error & Previous Error	% of full scale

Parallel

The parallel form allows the user to enter all parameters as Gains. In all cases, larger gain values result in faster output response.

Parameter	Description	Units
K_p	Proportional Gain	unitless
K_i	Integral Gain	1/seconds
K_d	Derivative Gain	seconds

$$Output (\%) = K_p e(t) + K_i \int e(t)dt + K_d \frac{de(t)}{dt}$$

Integral Value Management

To determine the integral component of the PID calculation, the controller software must maintain a running total of the accumulated area under the error curve (Current Integral). The sign of the value added to the accumulated Current Integral during each cycle may be positive or negative based on the current Direction setting as well as the relative values of the current process reading and the set point.

Override Control

The Current Integral accumulates when the output is set to Auto mode. If the controller is switched to Off mode, the value no longer accumulates, but it is not cleared. Therefore, PID control will resume where it left off if the controller is switched from Off back to Auto. Similarly, accumulation of the Control Integral will be suspended if the output is interlocked and resume after the lock-out is removed.

Bumpless Transfer

When the output is switched from Hand to Auto mode, the controller calculates a value for the Current Integral using the current error to generate the same output percent as the Hand Output setting. This calculation does not use the Derivative tuning setting to minimize errors from momentary fluctuations in the input signal. This feature ensures a smooth transition from manual to automatic control with minimal overshoot or undershoot as long as the user sets the Hand Output percentage close to the value that the process is expected to require for optimal control in Auto mode.

Wind-up Suppression

The Current Integral value that is accumulating while the output is set to

Auto can become very large or very small if the process value remains on the same side of the set point for a prolonged period of time. However, the controller may not be able to continue to respond if its output is already set to the minimum or maximum limits (0-100% by default). This condition is referred to as Control Wind-Up and can result severe overshoot or undershoot after a prolonged upset has ended.

For example, if the process value remains far below the set point despite a control output being pinned at 100%, the Current Integral will continue to accumulate errors (wind-up). When the process value finally rises to above the set point, negative errors will begin to decrease the Current Integral value. However, the value may remain large enough to keep the output at 100% long after the set point is satisfied. The controller will overshoot the set point and the process value will continue to rise.

To optimize system recovery after wind-up situations, the controller suppresses updates to the Current Integral that would drive the output beyond its minimum or maximum limit. Ideally, the PID parameters will be tuned and the control elements (pump, valves, etc.) will be sized properly so that the output never reaches its minimum or maximum limit during normal control operations. But with this wind-up suppression feature, overshoot will be minimized should that situation occur.

Output Details

The details for this type of output include the pulse rate in %, HOA mode or Interlock status, input value, current integral, current and accumulated on-times, alarms related to this output, relay type, and the current control mode setting.

Set Point	Numeric entry of a process value used as a target for PID control. The default value, units and display format (number of decimal places) used during data entry are defined based on the Input channel setting selected.
Gain	When the Gain Form setting is Standard, this unitless value is multiplied by the total of the proportional, integral, and derivative terms to determine the calculated output percent.
Proportional Gain	When the Gain Form setting is Parallel, this unitless value is multiplied by the normalized error (current process value versus set point) to determine the proportional component of the calculated output percent.
Integral Time	When the Gain Form setting is Standard, this value is divided into the integral of the normalized error (area under the error curve), then multiplied by the Gain to determine the integral component of the calculated output percent.

Integral Gain	When the Gain Form setting is Parallel, this value is multiplied by the integral of the normalized error (area under the error curve) to determine the integral component of the calculated output percent.
Derivative Time	When the Gain Form setting is Standard, this value is multiplied by the change in error between the current reading and the previous reading, then multiplied by the Gain to determine the derivative component of the calculated output percent.
Derivative Gain	When the Gain Form setting is Parallel, this value is multiplied by the change in error between the current reading and the previous reading to determine the derivative component of the calculated output percent.
Reset PID Integral	The PID Integral Value is a running total of the accumulated area under the error curve (Current Integral). When this menu option is selected, this total is set to zero and the PID algorithm is reset to its initial state.
Minimum Output	Enter the lowest possible pulse rate as a percentage of the Maximum Stroke Rate set below (normally 0%).
Maximum Output	Enter the highest possible pulse rate as a percentage of the Maximum Stroke Rate set below.
Maximum Rate	Enter the maximum pulse rate that the metering pump is designed to accept (10 – 480 pulse/minute range).
Input	Select the sensor to be used by this relay
Direction	Set the control direction. This setting is used to determine the sign of the calculated error (current process value versus set point) and allows flexible control with only positive values for all PID tuning parameters.
Input Minimum	The low end of the sensor input range, used to normalize errors into percent of full scale units. These values are set to the nominal range of the selected input sensor by default.
Input Maximum	The high end of the sensor input range, used to normalize errors into percent of full scale units. These values are set to the nominal range of the selected input sensor by default.
Gain Form	Select the PID Equation Format used to enter tuning parameters.

5.3.7 Relay, Dual Set Point Mode

Output Details

The details for this type of output include the relay on/off state, HOA mode or Interlock status, accumulated on-time, alarms, current cycle on time and relay type.

Settings

Press the Settings key view or change the settings related to the relay.

Set point	Enter the first sensor process value at which the relay will activate.
Set point 2	Enter the second sensor process value at which the relay will activate.
Deadband	Enter the sensor process value away from the set point at which the relay will deactivate.
Duty Cycle Period	Using a duty cycle helps to prevent overshooting the set point in applications where the response of the sensor to chemical additions is slow. Specify the amount of time for the cycle, and the percentage of that cycle time that the relay will be active. The relay will be off for the rest of the cycle, even if the set point has not been satisfied. Enter the length of the duty cycle in minutes:seconds in this menu. Set the time to 00:00 if use of a duty cycle is not required.
Duty Cycle	Enter the percentage of the cycle period that the relay will be active. Set the percentage to 100 if use of a duty cycle is not required.
Input	Select the sensor to be used by this relay.
Direction	Select the control direction. In Range will activate the relay when the input reading is between the two set points. Out of Range will activate the relay when the input reading is outside the two set points.

5.3.8 Relay or Analog Output, Manual Mode

Output Details

The details for this type of output include the relay on/off state or analog output %, HOA mode or Interlock status, accumulated on-time, alarms, current cycle on time and relay type.

Settings

A Manual relay will activate if the HOA mode is Hand, or if it is Activated With another channel. There are no additional programmable parameters.

5.3.9 Relay, Flow Timer Control Mode

Output Details

The details for this type of output include the relay on/off state, HOA mode or Interlock status, accumulated on-time and alarms.

Settings

Press the Settings key view or change the settings related to the relay.

Feed Duration	Enter the amount of time for the relay to activate for once the accumulated volume through the water meter has been reached.
----------------------	--

Accumulated Volume	Enter the volume of water to pass through the water meter required to trigger the chemical feed.
Input	Select the input to be used to control this output.
Reset Timer	Use this menu to cancel the current feed cycle.

5.3.10 Relay, Percent Timer Control Mode

Output Details

The details for this type of output include the relay on/off state, HOA mode or Interlock status, cycle time, accumulated on-time, alarms, current cycle on time and relay type.

Settings

Press the Settings key view or change the settings related to the relay.

Sample Period	Enter the duration of the sample period.
Feed Percentage	Enter the % of the sample period time to use for the feed relay activation time

5.3.11 Relay, Timer Control Mode

ONLY AVAILABLE IF HVAC MODES ARE DISABLED IN CONFIG MENU – GLOBAL SETTINGS

Basic Timer Operation

When a timer event triggers the algorithm will activate the relay for the programmed time.

Special Condition Handling

Overlapping timer events

If a second timer event occurs while the first one is still active, the second event will be ignored. An Event Skipped alarm will be set.

Interlock Conditions

Interlocks override the relay control, but do not change the operation of the timer control.

A digital input or output interlock condition does not delay the relay activation. The relay activation duration timer will continue even if the relay is deactivated due to an interlock condition. This will prevent delayed events which can potentially cause problems in they do not occur at the correct time.

“Activate With” Conditions

“Activate with channels” settings override the relay control, but do not change the operation of the timer control. The relay activation duration timer continues counting when the timer relay is forced on, and ends at the expected time (event start time plus duration). If the “activate with” condition continues after the end of the event time, the relay remains activated.

Alarms

An Event Skipped alarm is set when a second timer event occurs while one event is still running.

An Event Skipped alarm is also set when the timer relay never turns on during an event because of an interlock condition.

The alarm is cleared when the relay is next activated for any reason (the next timer event or HAND mode or “activate with” force on condition).

Output Details

The details for this type of output include the relay on/off state, HOA mode or Interlock status, accumulated on-time, alarms, current cycle on time and relay type. The current week number and day of the week is displayed (even if there is no multi-week repetition event programmed). Cycle Time shows the time counting down of the currently active part of the cycle.

Settings

Press the Settings key view or change the settings related to the relay.

Event 1 (through 10)	Enter these menus to program timer events via the menus below:
Repetition	Select the time cycle to repeat the event: Hourly, Daily, 1 Week, 2 Week, 4 Week, or None. An event means that the output is turned on at the same time of day, for the same amount of time, and except for the Daily cycle, on the same day of the week.
Week	Only appears if Repetition is longer than 1 Week. Select the week during which the event will occur.
Day	Only appears if Repetition is longer than Daily. Select the day of the week during which the event will occur.
Events Per Day	Only appears if Repetition is Hourly. Select the number of events per day. The events occur on the Start Time and then evenly spaced throughout the day.
Start Time	Enter the time of day to start the event.
Duration	Enter the amount of time that the relay will be on.
Add Last Missed	Select Enabled if the controller should delay start the most recent Biocide cycle until immediately after an Interlock clears, or Disabled if all Biocide feed should be skipped if there is an Interlock condition at the time the add was due to start.

5.3.12 Relay, Probe Wash Control Mode

Basic Timer Operation

When a Probe Wash event triggers, the algorithm will activate the relay for the programmed time. The relay will activate a pump or valve to supply a cleaning solution to the sensor or sensors. The output of the selected sensors

will either be held or disabled during the cleaning cycle, and for a programmable hold time after the cleaning cycle.

Special Condition Handling

Overlapping timer events

If a second timer event occurs while the first one is still active, the second event will be ignored. An Event Skipped alarm will be set.

Interlock Conditions

Interlocks override the relay control, but do not change the operation of the timer control.

A digital input or output interlock condition does not delay the relay activation. The relay activation duration timer will continue even if the relay is deactivated due to an interlock condition. This will prevent delayed events which can potentially cause problems if they do not occur at the correct time.

“Activate With” Conditions

“Activate with channels” settings override the relay control, but do not change the operation of the timer control. The relay activation duration timer continues counting when the timer relay is forced on, and ends at the expected time (event start time plus duration). If the “activate with” condition continues after the end of the event time, the relay remains activated.

Alarms

An Event Skipped alarm is set when a second timer event occurs while one event is still running.

An Event Skipped alarm is also set when the timer relay never turns on during an event because of an interlock condition.

The alarm is cleared when the relay is next activated for any reason (the next timer event or HAND mode or “activate with” force on condition).

Output Details

The details for this type of output include the relay on/off state, HOA mode or Interlock status, accumulated on-time, alarms, current cycle on time and relay type. The current week number and day of the week is displayed (even if there is no multi-week repetition event programmed). Cycle Time shows the time counting down of the currently active part of the cycle.

Settings

Press the Settings key view or change the settings related to the relay.

Event 1 (through 10)	Enter these menus to program timer events via the menus below:
Repetition	Select the time cycle to repeat the event: Hourly, Daily, 1 Week, 2 Week, 4 Week, or None. An event means that the output is turned on at the same time of day, for the same amount of time, and except for the Daily cycle, on the same day of the week.
Week	Only appears if Repetition is longer than 1 Week. Select the week during which the event will occur.

Day	Only appears if Repetition is longer than Daily. Select the day of the week during which the event will occur.
Events Per Day	Only appears if Repetition is Hourly. Select the number of events per day. The events occur on the Start Time and then evenly spaced throughout the day.
Start Time	Enter the time of day to start the event.
Duration	Enter the amount of time that the relay will be on.
Input	Select the sensor that will be washed.
Input 2	Select the second sensor, if applicable, that will be washed.
Sensor Mode	Select the effect that the probe wash event will have on any control outputs that use the sensor(s) being washed. The options are to either Disable the sensor readings (turn the control output off) or Hold the sensor reading at the last valid sensor reading prior to the start of the probe wash event.
Hold Time	Enter the amount of time needed to hold the sensor reading after the event has finished, in order for the wash solution to be replaced by process solution.

5.3.13 Analog Output, Retransmit Mode

Output Details

The details for this type of output include the output %, HOA mode or Interlock status, accumulated on-time, alarms, current cycle on time and relay type.

Settings

Press the Settings key view or change the settings related to the analog output.

4 mA Value	Enter the process value to correspond to a 4 mA output signal.
20 mA Value	Enter the process value to correspond to a 20 mA output signal.
Hand Output	Enter the output % desired when the output is in Hand mode.
Input	Select the sensor input to retransmit.

5.3.14 Analog Output, Proportional Control Mode

Output Details

The details for this type of output include the output %, HOA mode or Interlock status, accumulated on-time, alarms, current cycle on time and relay type.

Settings

Press the Settings key view or change the settings related to the analog output.

Set point	Enter the sensor process value at which the output % will be the programmed minimum %.
Proportional Band	Enter the sensor process value away from the set point at which the output % will be the programmed maximum %.

Minimum Output	Enter the lowest output %. If the output should be off at the set point, this will be 0%.
Maximum Output	Enter the highest output %.
Hand Output	Enter the output % desired when the output is in Hand mode.
Input	Select the sensor input to use for proportional control.
Direction	Select the control direction.
Off Mode Output	Enter the output mA value desired when the output is in Off mode, or being Interlocked, or during a calibration of the sensor being used as an input. The acceptable range is 0 to 21 mA.
Error Output	Enter the output mA desired when the sensor is not giving the controller a valid signal. The acceptable range is 0 to 21 mA.

5.3.15 Analog Output, PID Control Mode

ONLY AVAILABLE IF CONTROLLER INCLUDES ANALOG OUTPUT HARDWARE AND HAVC MODE IS DISABLED

The PID algorithm controls an analog (4-20 mA) output using standard Proportional-Integral-Derivative control logic. The algorithm provides feedback control based on an error value continuously calculated as the difference between a measured process variable and a desired set point. Tuning settings specify the response for proportional (the size of the error), integral (the time that the error has been present), and derivative (the rate of change for the error) parameters. With proper tuning, the PID control algorithm can hold the process value close the set point while minimizing overshoot and undershoot.

Normalized Error

The error value versus set point that is calculated by the controller is normalized and represented as percent of full scale. As a result, tuning parameters entered by the user are not dependent upon the scale of the process variable and the PID response with similar settings will be more consistent even when using different types of sensor inputs.

The scale used to normalize the error is dependent upon the type of sensor selected. By default, the full nominal range of the sensor is used. This range is editable by the user if tighter control is desired.

PID Equation Formats

The controller supports two different forms of the PID equation as specified by the Gain Form setting. The two forms require different units for entry of the PID tuning parameters.

Standard

The standard form is more commonly used in industry because its time-based settings for the integral and derivative coefficients are more meaningful. This form is selected by default.

Parameter	Description	Units
K_p	Gain	unitless
T_i	Integral Time	seconds
T_d	Derivative Gain	seconds or seconds/repeat

$$Output (\%) = K_p \left[e(t) + \frac{1}{T_i} \int e(t)dt + T_d \frac{de(t)}{dt} \right]$$

Parameter	Description	Units
$e(t)$	Current Error	% of full scale
dt	Delta Time Between Readings	seconds
$de(t)$	Difference Between Current Error & Previous Error	% of full scale

Parallel

The parallel form allows the user to enter all parameters as Gains. In all cases, larger gain values result in faster output response. This form is used in the WebMaster controller and is used internally by the Control Module.

Parameter	Description	Units
K_p	Proportional Gain	unitless
K_i	Integral Gain	1/ seconds
K_d	Derivative Gain	seconds

$$Output (\%) = K_p e(t) + K_i \int e(t)dt + K_d \frac{de(t)}{dt}$$

Integral Value Management

To determine the integral component of the PID calculation, the controller software must maintain a running total of the accumulated area under the error curve (Current Integral). The sign of the value added to the accumulated Current Integral during each cycle may be positive or negative based on the current Direction setting as well as the relative values of the current process reading and the set point.

Override Control

The Current Integral accumulates when the output is set to Auto mode. If the controller is switched to Off mode, the value no longer accumulates, but it is not cleared. Therefore, PID control will resume where it left off if the controller is switched from Off back to Auto. Similarly, accumulation of the Control Integral will be suspended if the output is interlocked and resume after the lock-out is removed.

Bumpless Transfer

When the output is switched from Hand to Auto mode, the controller calculates a value for the Current Integral using the current error to generate the same output percent as the Hand Output setting. This calculation does not use the Derivative tuning setting to minimize errors from momentary fluctuations in the input signal. This feature ensures a smooth transition from manual to automatic control with minimal overshoot or undershoot as long as the user sets the Hand Output percentage close to the value that the process is expected to require for optimal control in Auto mode.

Wind-up Suppression

The Current Integral value that is accumulating while the output is set to Auto can become very large or very small if the process value remains on the same side of the set point for a prolonged period of time. However, the controller may not be able to continue to respond if its output is already set to the minimum or maximum limits (0-100% by default). This condition is referred to as Control Wind-Up and can result severe overshoot or undershoot after a prolonged upset has ended.

For example, if the process value remains far below the set point despite a control output being pinned at 100%, the Current Integral will continue to accumulate errors (wind-up). When the process value finally rises to above the set point, negative errors will begin to decrease the Current Integral value. However, the value may remain large enough to keep the output at 100% long after the set point is satisfied. The controller will overshoot the set point and the process value will continue to rise.

To optimize system recovery after wind-up situations, the controller suppresses updates to the Current Integral that would drive the output beyond its minimum or maximum limit. Ideally, the PID parameters will be tuned and the control elements (pump, valves, etc.) will be sized properly so that the output never reaches its minimum or maximum limit during normal control operations. But with this wind-up suppression feature, overshoot will be minimized should that situation occur.

Output Details

The details for this type of output include the analog output value in %, HOA mode or Interlock status, input value, current integral, current and accumulated on-times, alarms related to this output, and the current control mode setting.

Set Point	Numeric entry of a process value used as a target for PID control. The default value, units and display format (number of decimal places) used during data entry are defined based on the Input channel setting selected.
Gain	When the Gain Form setting is Standard, this unitless value is multiplied by the total of the proportional, integral, and derivative terms to determine the calculated output percent.
Proportional Gain	When the Gain Form setting is Parallel, this unitless value is multiplied by the normalized error (current process value versus set point) to determine the proportional component of the calculated output percent.
Integral Time	When the Gain Form setting is Standard, this value is divided into the integral of the normalized error (area under the error curve), then multiplied by the Gain to determine the integral component of the calculated output percent.
Integral Gain	When the Gain Form setting is Parallel, this value is multiplied by the integral of the normalized error (area under the error curve) to determine the integral component of the calculated output percent.
Derivative Time	When the Gain Form setting is Standard, this value is multiplied by the change in error between the current reading and the previous reading, then multiplied by the Gain to determine the derivative component of the calculated output percent.
Derivative Gain	When the Gain Form setting is Parallel, this value is multiplied by the change in error between the current reading and the previous reading to determine the derivative component of the calculated output percent.
Reset PID Integral	The PID Integral Value is a running total of the accumulated area under the error curve (Current Integral). When this menu option is selected, this total is set to zero and the PID algorithm is reset to its initial state.
Minimum Output	Enter the lowest possible output value (normally 0%).
Maximum Output	Enter the highest possible output value as a percentage.
Off Mode Output	Enter the output mA value desired when the output is in Off mode, or being Interlocked, or if the Output Time Limit has expired, or during a calibration of the sensor being used as an input. Also if there is a Probe Wash programmed for the sensor, and the Sensor Mode option is set to Disable the output during the Wash cycle (if the Sensor Mode option is set to Hold the output holds its last setting and the Integral is not updated during the Wash). The acceptable range is 0 to 21 mA.
Error Output	Enter the output mA desired when the sensor is not giving the controller a valid signal. The acceptable range is 0 to 21 mA.
Input	Select the sensor to be used by this output.
Direction	Set the control direction. This setting is used to determine the sign of the calculated error (current process value versus set point) and allows flexible control with only positive values for all PID tuning parameters.

Input Minimum	The low end of the sensor input range, used to normalize errors into percent of full scale units. These values are set to the nominal range of the selected input sensor by default.
Input Maximum	The high end of the sensor input range, used to normalize errors into percent of full scale units. These values are set to the nominal range of the selected input sensor by default.
Gain Form	Select the PID Equation Format used to enter tuning parameters.

5.3.16 Analog Output, Flow Proportional Mode

Overview

In Flow Proportional control mode, the controller monitors the rate of flow through an analog or digital flow meter, and continuously adjusts the analog (4-20 mA) output proportional band to achieve a target PPM level.

The user enters the target PPM and the data necessary to calculate the proportional band (the water flow rate at which the maximum pulse rate will occur) required to maintain the target PPM with that flow rate of water.

$$\% \text{ output} = \frac{\text{Target PPM} \times \text{Water Flow Rate (liter/min or gal/min)}}{\text{Cycles} \times \text{Pump Rating (liter or gal/hr)} \times \text{Pump Setting (\%)} \times \text{Specific Gravity} \times 166.67}$$

$$\% \text{ output} = \frac{\text{Target PPM} \times \text{Water Flow Rate (m}^3\text{/min)}}{\text{Cycles} \times \text{Pump Rating (liter/hr)} \times \text{Pump Setting (\%)} \times \text{Specific Gravity} \times 0.16667}$$

Control Operation

If the output is continuously on for longer than the Output Time Limit, then output will deactivate.

Output Details

The details for this type of output include the output %, HOA mode or Interlock status, alarms related to this output, current cycle on time, total accumulated on-time, cycles of concentration, mA output, and the current control mode setting.

Settings

Touch the Settings icon to view or change the settings related to the relay.

Target	Enter the desired PPM set point for the product.
Pump Capacity	Enter the maximum flow rate for the metering pump.

Pump Setting	Enter the stroke length setting for the metering pump, in percent.
Specific Gravity	Enter the specific gravity of the product to be added.
Hand Output	Enter the output % desired when the output is in Hand mode.
Off Mode Output	Enter the output mA value desired when the output is in Off mode, or being Interlocked, or during a calibration of the sensor being used as an input. The acceptable range is 0 to 21 mA.
Error Output	Enter the output mA desired when the sensor is not giving the controller a valid signal. The acceptable range is 0 to 21 mA.
Flow Input	Select the flow meter to be used as an input for this control relay.

5.4 Settings Menu

The configuration Settings Menu is used for settings and activities that are not tied to Inputs or Outputs.

5.4.1 Global Settings

Date	Enter the current year, month and day.
Time	Enter the current hour (military time), minute, and second.
Global Units	Select the units to be used for cable length and wire gauge settings, metric or Imperial.
Temperature Units	Select between Fahrenheit and Celsius.
Alarm Delay	Enter how much time to wait after powering up the controller before alarm conditions are considered valid.
HVAC Modes	Enable HVAC modes for cooling tower and boiler applications where the relay control modes for Biocide timer, Bleed and Feed, Bleed then Feed, and Intermittent Sampling are required. Disable HVAC Modes if these control modes are not necessary and a more generic timer control mode will replace the Biocide timer.
Language	Select the language the software will use

5.4.2 Security Settings

Controller Log Out	Logging Out when Security is Enabled, and after the password has been entered, requires immediate use of a password to calibrate or change settings. If not manually logged out, the controller will automatically log out after 10 minutes of inactivity.
---------------------------	--

Security	Select Enable to require a password in order to calibrate or change settings, or Disable to allow calibration and set point changes without a password.
Local Password	Used to change the password needed for full configuration capability if Security has been enabled. The default local password is 5555. This can and should be changed using this menu if Security is enabled.

5.4.3 Display Settings

Home 1	Select the input or output to display on the 1 st line of the display Home screen.
Home 2	Select the input or output to display on the 2 nd line of the display Home screen.
Adjust Display	Change the contrast using the arrow keys. If the display becomes unreadable, it is possible to reset the defaults by powering down and pressing the bottom right button while powering back on.
Key Beep	Select enable to hear a beep when a key is pressed, or disable for silence

5.4.4 File Utilities

File Transfer Status	Displays the status of the last attempt to export a file
Export Event Log	Save the Event Log file to a USB stick. A micro-USB male to USB A female adapter is required. This records set point changes, user calibrations, alarms, relay state changes, file exports, etc.
Import User Config File	Remove power from the controller and insert a USB stick (a micro-USB male to USB A female adapter is required) that contains the settings that you want to import to this controller (see Export User Config file below). Press the Enter key and then press the Confirm key to transfer those settings to this controller.
Export User Config File	The User Configuration file contains all settings for the controller. Enter this menu to save the controller's settings to a USB stick for using later to restore settings to this controller, or to program additional controllers with the same settings as this one. It takes several minutes to create the file and transfer it to the stick. Remove power from the controller and insert a USB stick (a micro-USB male to USB A female adapter is required). Press the Enter key and then press the Confirm key to transfer a file containing the controller's settings to the USB stick.
Export System Log	Save the System Log file to a USB stick. A micro-USB male to USB A female adapter is required. This records hardware changes, software upgrades, automatic calibrations, power loss, system-level issues, etc.

Reset Default Config	Enter this menu to restore all of the settings to the factory default values. Any changes to settings that were previously made will be lost!
Software Upgrade	Remove power from the controller and insert an USB stick that has the upgrade file stored in the root directory into the micro-USB connector (see figure 1). A micro-USB male to USB A female adapter is required. Press the Enter key, and then press the Confirm key to start the upgrade.

NOTE: Remove power before inserting or removing the micro-USB adapter!

5.4.5 Controller Details

Controller	Displays the name for the group of default settings used as built
Product Name	Displays the model of the controller as built
Control Board	Displays the revision number of the front panel circuit board
Software Version	Displays the software version on the control board
Sensor Board	Displays the revision number of the sensor board
Software Version	Displays the software version on the sensor board
Power Board	Displays the revision number of the power/relay board
Display Board	Displays the revision number of the display board
AO Board	Displays the revision number of the analog output board
Battery Power	Displays the VDC output of the battery that is used to hold the date and time. The acceptable range is 2.4-3.2 VDC.
Processor Temp	Displays the temperature of the main processor. The acceptable range is -10 to 65 C.
Sensor Temp	Displays the temperature of the sensor input processor. The acceptable range is -10 to 65 C.

6.0 MAINTENANCE

The controller itself requires very little maintenance. Wipe with a damp cloth. Do not spray down the controller unless the panel door is closed and latched.

7.0 TROUBLESHOOTING

CAUTION: Disconnect power to the controller before opening front panel!

Troubleshooting and repair of a malfunctioning controller should only be attempted by qualified personnel using caution to ensure safety and limit unnecessary further damage. Contact the factory.

7.1 Calibration Failure

Calibrations will fail if the adjustments to the reading are outside of the normal range for a properly functioning system. Refer to the instruction manual for the specific sensor being used for further information.

7.1.1 Contacting Conductivity Sensors

The calibration will fail if the adjustment to the gain is outside of 0.5 to 2.0.

Possible Cause	Corrective Action
Dirty electrode	Clean electrode
Improper wiring of sensor to controller	Correct wiring
Wrong cell constant entered	Program the controller cell constant setting at the value that matches the electrode being used
Incorrect temperature reading or setting	Ensure that the temperature is accurate
Incorrect cable length or wire gauge setting	Set to the correct values
Faulty electrode	Replace electrode

7.1.2 Electrodeless Conductivity Sensors

The calibration will fail if the adjustment to the gain is outside of 0.2 to 10, or the offset is outside of -10,000 to 10,000.

Possible Cause	Corrective Action
Dirty sensor	Clean sensor
Improper wiring of sensor to controller	Correct wiring
Sensor placed too close to container walls	Relocate sensor
Sensor placed in the direct path of electrical current flow	Relocate sensor
Incorrect temperature reading or setting	Ensure that the temperature is accurate
Incorrect cable length or wire gauge setting	Set to the correct values
Faulty sensor	Replace sensor

7.1.3 pH Sensors

The calibration will fail if the adjustment to the gain is outside of 0.2 to 1.2, or if the calculated offset is outside of -140 to 140.

Possible Cause	Corrective Action
Dirty electrode	Clean electrode
Improper wiring of sensor to controller	Correct wiring

Incorrect temperature reading or setting	Ensure that the temperature is accurate
Incorrect cable length or wire gauge setting	Set to the correct values
Faulty electrode	Replace electrode
Faulty preamplifier	Replace preamplifier

7.1.4 ORP Sensors

The calibration will fail if the adjustment to the gain is outside of 0.5 to 1.5, or if the calculated offset is outside of -300 to 300.

Possible Cause	Corrective Action
Dirty electrode	Clean electrode
Improper wiring of sensor to controller	Correct wiring
Faulty electrode	Replace electrode
Faulty preamplifier	Replace preamplifier

7.1.5 Disinfection Sensors

The calibration will fail if the adjustment to the gain is outside of 0.2 to 10.0, or if the calculated offset is outside of -40 to 40.

Possible Cause	Corrective Action
Insufficient conditioning	Wait for the appropriate amount of time before attempting a calibration.
Insufficient sample flow	Increase flow rate to between 30 and 100 liter per hour.
Air bubbles on membrane	Dislodge bubbles. Adjust flow rate higher if necessary.
Air bubbles in electrolyte	Refill membrane cap with electrolyte.
Dirty membrane	Clean membrane
Loose membrane cap	Tighten membrane cap.
Faulty membrane	Replace membrane cap.
High Pressure	Reduce pressure to below 1 atmosphere and refill cap with electrolyte
No electrolyte fill solution in membrane cap	Fill membrane cap with electrolyte. Replace membrane cap if it will not hold solution.
Improper wiring of sensor to controller	Correct wiring
Faulty sensor	Replace sensor
Faulty analysis equipment or reagents	Consult test equipment instructions
Sample contaminated with interfering molecule (refer to Sensitivity specification in sensor instructions)	Remove source of contamination

7.2 Alarm Messages

Alarm messages will include the Name of the input or output as defined in the Settings menu, the hardware identifying type and number (S for sensor input, D for digital input, R for relay output, A for analog output), and the type of alarm.

HIGH or HIGH-HIGH ALARM	
Occurs if the sensor reading rises above the high alarm set points. If your unit is programmed for an alarm relay output, the alarm relay will activate. The controller will continue to check the sensor reading, and any outputs using the sensor will remain active.	
Possible Cause	Corrective Action
The process went further out of control than normal.	May have to increase chemical flow rate.
The chemical supply has run out.	Replenish the chemical supply.
The pump or valve or supply line is faulty.	Repair or replace the control device.
Wrong chemical is being controlled.	Replace with correct chemical.
The sensor is not responding to changes.	Repair or replace sensor. Evaluate mixing or recirculation.
The pump is siphoning, valve leaking.	Repair or replace the control device or re-route tubing.
Control output has been left in “HAND” mode.	Switch back to “AUTO”.
It may be a normal part of the process.	None required.
LOW or LOW-LOW ALARM	
Occurs if the sensor reading drops below the low alarm set points. If your unit is programmed for an alarm relay output, the alarm relay will activate. The controller will continue to check the sensor reading, and any outputs using the sensor will remain active.	
Possible Cause	Corrective Action
The process went further out of control than normal.	May have to increase chemical flow rate.
The chemical supply has run out.	Replenish the chemical supply.
The pump or valve or supply line is faulty.	Repair or replace the control device.
Wrong chemical is being controlled.	Replace with correct chemical.
The sensor is not responding to changes.	Repair or replace sensor. Evaluate mixing or recirculation.
The pump is siphoning, valve leaking.	Repair or replace the control device or re-route tubing.
Control output has been left in “HAND” mode.	Switch back to “AUTO”.
It may be a normal part of the process.	None required.

DI STATE CUSTOM MESSAGE	
A digital input that is a DI State type can be set such that either the open or closed state generates an alarm. The alarm message may be customized. The most common use for this will be a Flow Switch.	
Possible Cause	Corrective Action
No flow	Check piping for closed valves, blockage, etc. Check recirculation pump.
Faulty flow switch/cable	Check with ohmmeter.
Faulty controller	Check by shorting digital input in controller.
TOTAL ALARM	
Occurs if the flow meter totalizer alarm limit is exceeded.	
Normal operation	Reset the total to clear alarm
AC coupled onto flow meter cable	Route cable at least 6 inches (150 mm) away from any AC voltage
Noise coupled onto flow meter cable	Shield cable
OUTPUT TIMEOUT	
This error condition will stop control. It is caused by the output (either relay or analog) being activated for longer than the programmed Time Limit.	
Possible Cause	Corrective Action
The process went further out of control than normal.	Increase time limit or reset timer.
The chemical supply has run out.	Replenish the chemical supply.
The pump or valve or supply line is faulty.	Repair or replace the control device.
Wrong chemical is being controlled.	Replace with correct chemical.
The sensor is not responding to changes.	Replace sensor. Evaluate mixing or recirculation.
RANGE ALARM	
It indicates that the signal from the sensor is out of the normal range. This error condition will stop control of any output using the sensor. This prevents controlling based upon a false sensor reading. If the temperature sensor goes into range alarm, then the controller will go into manual temperature compensation using the Default Temperature setting.	
Possible Cause	Corrective Action
Sensor wires shorted	Disconnect short
Faulty sensor	Replace sensor
Faulty controller	Replace or repair controller
SENSOR FAULT	
This error indicates that the signal from the sensor is no longer valid at all. This error condition will stop control of any output using the sensor.	
Possible Cause	Correction Action
Sensor wires shorted	Disconnect short
Faulty sensor	Replace sensor

Faulty controller	Replace or repair controller
INPUT FAILURE This alarm indicates that the sensor input circuit is no longer working. This error condition will stop control of any output using the sensor.	
Possible Cause	Correction Action
Faulty controller	Replace or repair controller
BATTERY POWER LOW This alarm indicates that the battery which holds the date and time in memory is below 2.4 VDC.	
Possible Cause	Correction Action
Faulty battery	Replace battery
SYSTEM TEMP LOW This alarm indicates that the temperature inside the controller is below -10 °C.	
Possible Cause	Correction Action
Low ambient temperatures	Provide heat for the controller
SYSTEM TEMP HIGH This alarm indicates that the temperature inside the controller is above 75 °C	
Possible Cause	Correction Action
High ambient temperatures	Provide cooling for the controller
DISPLAY ERROR This alarm occurs if the user interface gets lost	
Possible Cause	Correction Action
Pressing keys very quickly	Exit out of the screen and continue programming
CONTROLLER, POWER, DISPLAY, OR SENSOR BOARD ERROR This alarm occurs if the board listed is not recognized	
Possible Cause	Correction Action
Faulty board	Return the controller for repair
CONTROLLER, POWER, SENSOR, DISPLAY, NETWORK OR ANALOG OUTPUT BOARD VARIANT This alarm occurs if the type of board that is detected is not a valid type	
Possible Cause	Correction Action
Faulty Board	Replace the board listed in the error message
INVALID CONTROL MODE This alarm occurs if the programmed control mode is not possible for the installed power relay board	
Possible Cause	Correction Action
The power relay board has been removed and replaced with an incorrect model	Reinstall the correct board or reprogram the output to a valid type for the board installed

SENSOR, DIGITAL INPUT, RELAY OR ANALOG OUTPUT DISABLED	
This alarm occurs if software for that input or output did not start correctly	
Possible Cause	Correction Action
The software is not functioning	If the error message clears on its own, no action is required. If the error message persists, cycle power. If the error message still persists, return the controller for repair.
RELAY OR ANALOG OUTPUT CONTROL FAILURE	
This alarm occurs if software for that output did not run correctly	
Possible Cause	Correction Action
The software is not functioning	If the error message clears on its own, no action is required. If the error message persists, cycle power. If the error message still persists, return the controller for repair.
FRAM FILE SYSTEM ERROR	
This alarm occurs if the FRAM is not detected at power up	
Possible Cause	Correction Action
The FRAM was or is not functioning	If the error message clears on its own, no action is required. If the error message persists, cycle power. If the error message still persists, return the controller for repair.

8.0 SERVICE POLICY

Walchem W100P series controllers have a 2-year warranty on electronic components and a 1-year warranty on mechanical parts and electrodes. See Statement of Limited Warranty in front of manual for details.

Walchem controllers are supported by a worldwide network of authorized master distributors. Contact your authorized Walchem distributor for troubleshooting support, replacement parts, and service. If a controller that is under warranty is not functioning properly, it may be exchanged after the problem has been confirmed as a manufacturing defect. Authorized distributors will provide a Return Material Authorization (RMA) number for any products being returned to the factory for warranty evaluation. Returns are generally processed in less than one week. Returns that are shipped to the factory by next-day-air freight will receive priority service. We will not issue RMAs for W100P Controllers that fail out of warranty since they are not serviceable and will need to be replaced.

FIVE BOYNTON ROAD
TEL: 508-429-1110

HOPPING BROOK PARK
USA

HOLLISTON, MA 01746
Web: www.walchem.com